

Flowconcept

TOP CONNECTIONS - BEST SOLUTIONS

LYNKOBLINGER · BLÆSEPISTOLER · LUFTBEHANDLING · FITTINGS · LUFTSLANGER · KOMPRESSORER · SLANGE- & KABELOPRULLERE



KATALOG/PRISLISTE

2017/2018



LYNKOBLINGER · NIPLER - SERIE 21, 021, 17, 19, 22 & 23

SIDE 6 - 13



LYNKOBLINGER · NIPLER - EUROPFIL, SERIE 26, 1625, 25, 007 & 009

SIDE 14 - 19



LYNKOBLINGER · NIPLER - SERIE 27, 1727, 33, 34 & KS 1/4"

SIDE 20 - 23



DOBBELTAFSPÆRRING LYNKOBLINGER · NIPLER - SERIE 21, 26, 25, 27, 71-76

SIDE 24 - 33



SIKKERHEDSLYNKOBLINGER · NIPLER - SERIE 21KS, 21KD, 95KS, 96KS, 1600KE & 009

SIDE 34 - 38



NITO VANDKOBLINGER & TILBEHØR

SIDE 39 - 46



FITTINGS

SIDE 47 - 50



SPÆNDEBÅND · SLANGEKLEMMER · PUMPENIPLER

SIDE 51



LYNFITTINGS · PUSH-IN · PA+PU SLANGE

SIDE 52 - 55



KABELBINDER · VÆRKTØJSOLIE · GEVINDTAPE · KUGLEHANER · LYDDÆMPERE

SIDE 56 - 58



SKUM- & BODYPISTOLER · BREMSEUDLUFTER · OLIEPÅFYLDER · RENSEPISTOLER SIDE 58 - 60



SANDBLÆSEPISTOLER · PUMPEPISTOLER · MALERPISTOLER SIDE 60 - 62



BLÆSEPISTOLER SIDE 63



TRYKLUFTSLANGER · SPIRALSLANGER SIDE 64 - 66



LUFTBEHANDLING · PREVOST RØRSYSTEM SIDE 67 - 74



KOMPRESSORER SIDE 75



RODCRAFT LUFTVÆRKTØJER · BALANCEVÆGTE · SPRØJTER SIDE 76 - 79



SLANGEOPRULLERE TIL LUFT · VAND · OLIE · FEDT · DIESEL · PROPAN · OXYGEN/ACETYLEN SIDE 80 - 116



KABELOPRULLERE SIDE 117 - 129

Rectus Serie	13	14	16	19	20	21C	22	23	24	25	27	30	31	32
Fabrikat														
Atlas Copco - QAC 08									X					
Atlas Copco - QAC 10														
Atlas Copco - QAC 15														
Clejn 220						X								
Clejn 231			X											
Clejn 300		X												
Clejn 310										X				
Clejn 320											X			
Clejn 341-342-343-345-346														
Clejn 344														

KONVERTERINGS TABEL SIDE 130

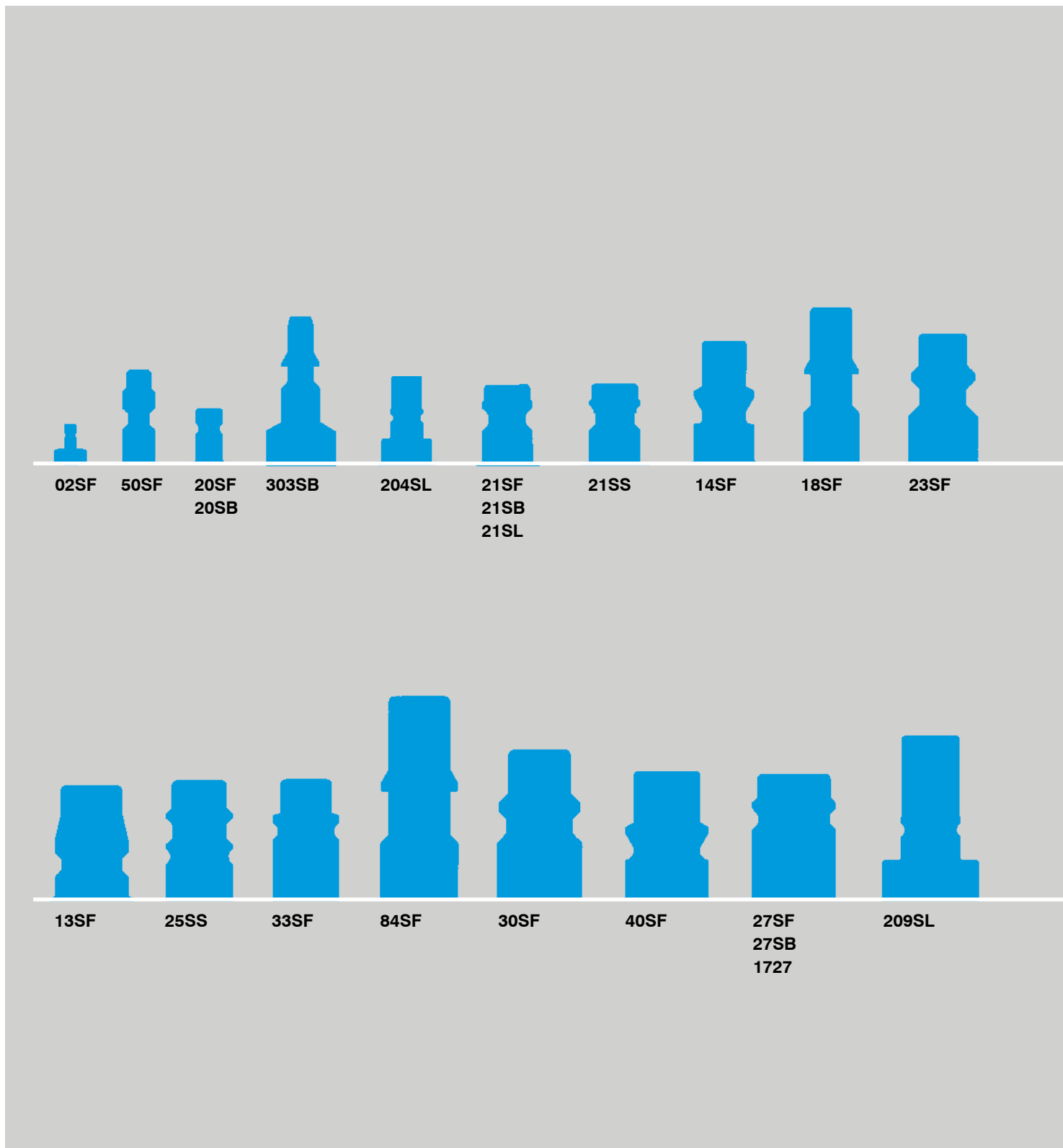

02SF

50SF

20SF
20SB

303SB

204SL

21SF
21SB
21SL

21SS

14SF

18SF

23SF

13SF

25SS

33SF

84SF

30SF

40SF

27SF
27SB
1727

209SL



206SL



31SF



**51SF
51SB**



**52SF
52SB**



48SF



**25SF
26SF
25SB
26SB
1625
1600KE
009**



95SS



96SS



32SF



34SF



28SS



37SF



57SF



**38SF
38SB**



**39SF
39SB
39SL**

SERIE 21 - Mini industrikobling

Lille kobling med høj luftgennemstrømning. Mange tilslutnings- & materiale muligheder. Flow 500 ltr/min.



Best. nr.	Artikelnummer	Tilslutning	Kr/stk
021010	21KA AW10 MPX	1/8" udvendig gevind, Messing	97,-
021010N	21KA AW10 MPN	1/8" udvendig gevind, Forniklet	106,-
021012	21KA AW13 MPX	1/4" udvendig gevind, Messing	100,-
021012N	21KA AW13 MPN	1/4" udvendig gevind, Forniklet	110,-
021014	21KA AW17 MPX	3/8" udvendig gevind, Messing	100,-
021014N	21KA AW17 MPN	3/8" udvendig gevind, Forniklet	110,-



Best. nr.	Artikelnummer	Tilslutning	Kr/stk
021000	21KA IW10 MPX	1/8" indvendig gevind, Messing	98,-
021000N	21KA IW10 MPN	1/8" indvendig gevind, Forniklet	107,-
021002	21KA IW13 MPX	1/4" indvendig gevind, Messing	100,-
021002N	21KA IW13 MPN	1/4" indvendig gevind, Forniklet	110,-
021004	21KA IW17 MPX	3/8" indvendig gevind, Messing	100,-
021004N	21KA IW17 MPN	3/8" indvendig gevind, Forniklet	110,-



Best. nr.	Artikelnummer	Tilslutning	Kr/stk
021104	21KA TF04 MPX	4 mm slangestuds, Messing	98,-
021104N	21KA TF04 MPN	4 mm slangestuds, Forniklet	107,-
021106	21KA TF06 MPX	6 mm slangestuds, Messing	98,-
021106N	21KA TF06 MPN	6 mm slangestuds, Forniklet	107,-
021108	21KA TF08 MPX	8 mm slangestuds, Messing	98,-
021108N	21KA TF08 MPN	8 mm slangestuds, Forniklet	110,-
021109	21KA TF09 MPX	9 mm slangestuds, Messing	98,-
021109N	21KA TF09 MPN	9 mm slangestuds, Forniklet	110,-
021110	21KA TF10 MPX	10 mm slangestuds, Messing	100,-
021110N	21KA TF10 MPN	10 mm slangestuds, Forniklet	111,-



Best. nr.	Artikelnummer	Tilslutning	Kr/stk
021136	21KA K006 MPX	4 x 6 mm klemstuds, Messing	103,-
021136N	21KA K006 MPN	4 x 6 mm klemstuds, Forniklet	117,-
021138	21KA K008 MPX	6 x 8 mm klemstuds, Messing	107,-
021138N	21KA K008 MPN	6 x 8 mm klemstuds, Forniklet	119,-



Best. nr.	Artikelnummer	Tilslutning	Kr/stk
021156	21KA KS06 MPX	4 x 6 mm klemstuds og skotgennemføring, M	132,-
021156N	21KA KS06 MPN	4 x 6 mm klemstuds og skotgennemføring, F	146,-
021158	21KA KS08 MPX	6 x 8 mm klemstuds og skotgennemføring, M	139,-
021158N	21KA KS08 MPN	6 x 8 mm klemstuds og skotgennemføring, F	151,-



Best. nr.	Artikelnummer	Tilslutning	Kr/stk
021144	21KA TS04 MPX	4 mm slangestuds og skotgennemføring, M	146,-
021144N	21KA TS04 MPN	4 mm slangestuds og skotgennemføring, F	153,-
021145	21KA TS05 MPX	5 mm slangestuds og skotgennemføring, M	146,-
021145N	21KA TS05 MPN	5 mm slangestuds og skotgennemføring, F	153,-
021146	21KA TS06 MPX	6 mm slangestuds og skotgennemføring, M	146,-
021146N	21KA TS06 MPN	6 mm slangestuds og skotgennemføring, F	153,-
021148	21KA TS08 MPX	8 mm slangestuds og skotgennemføring, M	151,-
021148N	21KA TS08 MPN	8 mm slangestuds og skotgennemføring, F	164,-
021140	21KA TS10 MPX	10 mm slangestuds og skotgennemføring, M	151,-
021140N	21KA TS10 MPN	10 mm slangestuds og skotgennemføring, F	164,-



Best. nr.	Artikelnummer	Tilslutning	Kr/stk
021166	21SF KK06 MPX	4 x 6 mm klemstuds og aflastningsfjeder, M	116,-
021166N	21SF KK06 MPN	4 x 6 mm klemstuds og aflastningsfjeder, F	126,-
021168	21SF KK08 MPX	6 x 8 mm klemstuds og aflastningsfjeder, M	116,-
021168N	21SF KK08 MPN	6 x 8 mm klemstuds og aflastningsfjeder, F	126,-



Best. nr.	Artikelnummer	Tilslutning	Kr/stk
021310	21SF AW10 MXX	1/8" udvendig gevind, Messing	16,-
021310N	21SF AW10 MXN	1/8" udvendig gevind, Forniklet	22,-
021312	21SF AW13 MXX	1/4" udvendig gevind, Messing	16,-
021312N	21SF AW13 MXN	1/4" udvendig gevind, Forniklet	24,-
021314	21SF AW17 MXX	3/8" udvendig gevind, Messing	23,-
021314N	21SF AW17 MXN	3/8" udvendig gevind, Forniklet	29,-



Best. nr.	Artikelnummer	Tilslutning	Kr/stk
021300	21SF IW10 MXX	1/8" indvendig gevind, Messing	16,-
021300N	21SF IW10 MXN	1/8" indvendig gevind, Forniklet	24,-
021302	21SF IW13 MXX	1/4" indvendig gevind, Messing	17,-
021302N	21SF IW13 MXN	1/4" indvendig gevind, Forniklet	24,-
021304	21SF IW17 MXX	3/8" indvendig gevind, Messing	21,-
021304N	21SF IW17 MXN	3/8" indvendig gevind, Forniklet	29,-



Best. nr.	Artikelnummer	Tilslutning	Kr/stk
021204	21SF TF04 MXX	4 mm slangestuds, Messing	9,-
021204N	21SF TF04 MXN	4 mm slangestuds, Forniklet	20,-
021205	21SF TF05 MXX	5 mm slangestuds, Messing	9,-
021205N	21SF TF05 MXN	5 mm slangestuds, Forniklet	20,-
021206	21SF TF06 MXX	6 mm slangestuds, Messing	9,-
021206N	21SF TF06 MXN	6 mm slangestuds, Forniklet	20,-
021208	21SF TF08 MXX	8 mm slangestuds, Messing	14,-
021208N	21SF TF08 MXN	8 mm slangestuds, Forniklet	21,-
021209	21SF TF09 MXX	9 mm slangestuds, Messing	14,-
021209N	21SF TF09 MXN	9 mm slangestuds, Forniklet	21,-
021210	21SF TF10 MXX	10 mm slangestuds, Messing	15,-
021210N	21SF TF10 MXN	10 mm slangestuds, Forniklet	22,-



Best. nr.	Artikelnummer	Tilslutning	Kr/stk
021336	21SF K006 MXX	4 x 6 mm klemstuds, Messing	19,-
021336N	21SF K006 MXN	4 x 6 mm klemstuds, Forniklet	27,-
021338	21SF K008 MXX	6 x 8 mm klemstuds, Messing	18,-
021338N	21SF K008 MXN	6 x 8 mm klemstuds, Forniklet	27,-
021330	21KA K010 MXX	8 x 10 mm klemstuds, Messing	39,-
021330N	21SF K010 MXN	8 x 10 mm klemstuds, Forniklet	45,-
021332	21SF K012 MXX	8 x 12 mm klemstuds, Messing	39,-
021332N	21SF K012 MXN	8 x 12 mm klemstuds, Forniklet	40,-



Best. nr.	Artikelnummer	Tilslutning	Kr/stk
021556	21SF KS06 MXX	4 x 6 mm klemstuds og skotgennemføring, M	47,-
021556N	21SF KS06 MXN	4 x 6 mm klemstuds og skotgennemføring, F	56,-
021558	21SF KS08 MXX	6 x 8 mm klemstuds og skotgennemføring, M	47,-
021558N	21SF KS08 MXN	6 x 8 mm klemstuds og skotgennemføring, F	57,-



Best. nr.	Artikelnummer	Tilslutning	Kr/stk
021445	21SF TS05 MXX	5 mm slangestuds og skotgennemføring, M	44,-
021445N	21SF TS05 MXN	5 mm slangestuds og skotgennemføring, F	51,-
021446	21SF TS06 MXX	6 mm slangestuds og skotgennemføring, M	44,-
021446N	21SF TS06 MXN	6 mm slangestuds og skotgennemføring, F	51,-
021448	21SF TS08 MXX	8 mm slangestuds og skotgennemføring, M	45,-
021448N	21SF TS08 MXN	8 mm slangestuds og skotgennemføring, F	54,-
021440	21SF TS10 MXX	10 mm slangestuds og skotgennemføring, M	46,-
021440N	21SF TS10 MXN	10 mm slangestuds og skotgennemføring, F	56,-



Best. nr.	Artikelnummer	Tilslutning	Kr/stk
021666	21SF KK06 MXX	4 x 6 mm klemstuds og aflastningsfjeder, M	39,-
021666N	21SF KK06 MXN	4 x 6 mm klemstuds og aflastningsfjeder, F	46,-
021668	21SF KK08 MXX	6 x 8 mm klemstuds og aflastningsfjeder, M	39,-
021668N	21SF KK08 MXN	6 x 8 mm klemstuds og aflastningsfjeder, F	46,-



Lynkoblinger fra **RECTUS** og **TEMA** til lav-, mellem- og højtryk
i mange forskellige design og kvaliteter.

SERIE 021 - Mini kobling som passer til Cejn serie 220

Lille kobling med høj luftgennemstrømning. Forniklet udførelse. Flow 500 ltr/min.



Best. nr.	Artikelnummer	Tilslutning	Kr/stk
021012C	21KA AW13 MPN S	1/4" udvendig gevind	113,-
021014C	21KA AW17 MPN S	3/8" udvendig gevind	144,-



Best. nr.	Artikelnummer	Tilslutning	Kr/stk
021000C	21KA IW10 MPN S	1/8" indvendig gevind	113,-
021002C	21KA IW13 MPN S	1/4" indvendig gevind	113,-
021004C	21KA IW17 MPN S	3/8" indvendig gevind	144,-



Best. nr.	Artikelnummer	Tilslutning	Kr/stk
021104C	21KA TF04 MPN S	4 mm slangestuds	113,-
021106C	21KA TF06 MPN S	6 mm slangestuds	113,-
021108C	21KA TF08 MPN S	8 mm slangestuds	113,-
021109C	21KA TF09 MPN S	9 mm slangestuds	113,-
021110C	21KA TF10 MPN S	10 mm slangestuds	113,-



Best. nr.	Artikelnummer	Tilslutning	Kr/stk
021310C	21SF AK10 SXN S	1/8" udvendig gevind	83,-
021312C	21SF AK13 SXN S	1/4" udvendig gevind	83,-
021314C	21SF AK17 SXN S	3/8" udvendig gevind	83,-



Best. nr.	Artikelnummer	Tilslutning	Kr/stk
021300C	21SF IW10 SXN S	1/8" indvendig gevind	83,-
021302C	21SF IW13 SXN S	1/4" indvendig gevind	83,-

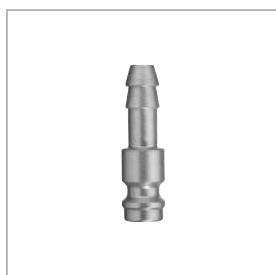

Best. nr.	Artikelnummer	Tilslutning	Kr/stk
021204C	21SF TF04 SXN S	4 mm slangestuds	83,-
021206C	21SF TF06 SXN S	6 mm slangestuds	83,-
021208C	21SF TF08 SXN S	8 mm slangestuds	83,-
021209C	21SF TF09 SXN S	9 mm slangestuds	83,-
021210C	21SF TF10 SXN S	10 mm slangestuds	83,-

SERIE 17 - Engelsk profil kompatibel med Schrader NW5

Designet til trykluft brug. Forniklet udførelse. Flow 850 ltr/min.



Best. nr.	Artikelnummer	Tilslutning	Kr/stk
017012	17KA AK13 SPN	1/4" udvendig gevind	131,-
017014	17KA AK17 SPN	3/8" udvendig gevind	131,-
017015	17KA AK21 SPN	1/2" udvendig gevind	145,-



Best. nr.	Artikelnummer	Tilslutning	Kr/stk
017002	17KA IW13 SPN	1/4" indvendig gevind	131,-
017004	17KA IW17 SPN	3/8" indvendig gevind	131,-
017005	17KA IW21 SPN	1/2" indvendig gevind	145,-



Best. nr.	Artikelnummer	Tilslutning	Kr/stk
017106	17KA TF06 SPN	6 mm slangestuds	131,-
017108	17KA TF08 SPN	8 mm slangestuds	131,-
017110	17KA TF10 SPN	10 mm slangestuds	131,-
017113	17KA TF13 SPN	13 mm slangestuds	131,-



Best. nr.	Artikelnummer	Tilslutning	Kr/stk
017206	17SF TF06 SXN	6 mm slangestuds	24,-
017208	17SF TF08 SXN	8 mm slangestuds	24,-
017210	17SF TF10 SXN	10 mm slangestuds	24,-
017213	17SF TF13 SXN	13 mm slangestuds	25,-



Best. nr.	Artikelnummer	Tilslutning	Kr/stk
017310	17SF AK10 SXN	1/8" udvendig gevind	27,-
017312	17SF AK13 SXN	1/4" udvendig gevind	25,-
017314	17SF AK17 SXN	3/8" udvendig gevind	25,-



Best. nr.	Artikelnummer	Tilslutning	Kr/stk
017300	17SF IW10 SXN	1/8" indvendig gevind	27,-
017302	17SF IW13 SXN	1/4" indvendig gevind	27,-

SERIE 19 - Engelsk profil kompatibel med PCL 60 (UK)

Designet til trykluft brug. Forniklet udførelse. Flow 850 ltr/min.



Best. nr.	Artikelnummer	Tilslutning	Kr/stk
019012	19KA AK13 MPN	1/4" udvendig gevind	159,-
019014	19KA AK17 MPN	3/8" udvendig gevind	159,-
019015	19KA AK21 MPN	1/2" udvendig gevind	163,-



Best. nr.	Artikelnummer	Tilslutning	Kr/stk
019002	19KA IW13 MPN	1/4" indvendig gevind	159,-
019004	19KA IW17 MPN	3/8" indvendig gevind	159,-
019005	19KA IW21 MPN	1/2" indvendig gevind	163,-



Best. nr.	Artikelnummer	Tilslutning	Kr/stk
019106	19KA TF06 MPN	6 mm slangestuds	159,-
019108	19KA TF08 MPN	8 mm slangestuds	159,-
019109	19KA TF09 MPN	9 mm slangestuds	159,-
019110	19KA TF10 MPN	10 mm slangestuds	159,-
019113	19KA TF13 MPN	13 mm slangestuds	159,-



Best. nr.	Artikelnummer	Tilslutning	Kr/stk
019206	19SF TF06 SXN	6 mm slangestuds	30,-
019208	19SF TF08 SXN	8 mm slangestuds	30,-
019210	19SF TF10 SXN	10 mm slangestuds	30,-



Best. nr.	Artikelnummer	Tilslutning	Kr/stk
019312	19SF AK13 SXN	1/4" udvendig gevind	30,-
019314	19SF AK17 SXN	3/8" udvendig gevind	30,-



Best. nr.	Artikelnummer	Tilslutning	Kr/stk
019302	19SF IW13 SXN	1/4" indvendig gevind	30,-
019304	19SF IW17 SXN	3/8" indvendig gevind	30,-

SERIE 22 - Industrikobling kompatibel med bl.a.

Orion 44510 og Rectus serie 14. Forniklet udførelse. Flow 1000 ltr/min.



Best. nr.	Artikelnummer	Tilslutning	Kr/stk
022012	22KA AK13 MPN	1/4" udvendig gevind	112,-
022014	22KA AK17 MPN	3/8" udvendig gevind	112,-
022015	22KA AK21 MPN	1/2" udvendig gevind	117,-



Best. nr.	Artikelnummer	Tilslutning	Kr/stk
022002	22KA IW13 MPN	1/4" indvendig gevind	112,-
022004	22KA IW17 MPN	3/8" indvendig gevind	112,-
022005	22KA IW21 MPN	1/2" indvendig gevind	117,-



Best. nr.	Artikelnummer	Tilslutning	Kr/stk
022106	22KA TF06 MPN	6 mm slangestuds	112,-
022108	22KA TF08 MPN	8 mm slangestuds	112,-
022109	22KA TF09 MPN	9 mm slangestuds	112,-
022110	22KA TF10 MPN	10 mm slangestuds	112,-
022113	22KA TF13 MPN	13 mm slangestuds	112,-



Best. nr.	Artikelnummer	Tilslutning	Kr/stk
022206	22SF TF06 SXN	6 mm slangestuds	20,-
022208	22SF TF08 SXN	8 mm slangestuds	20,-
022210	22SF TF10 SXN	10 mm slangestuds	20,-
022213	22SF TF13 SXN	13 mm slangestuds	21,-



Best. nr.	Artikelnummer	Tilslutning	Kr/stk
022312	22SF AK13 SXN	1/4" udvendig gevind	19,-
022314	22SF AK17 SXN	3/8" udvendig gevind	22,-
022315	22SF AK21 SXN	1/2" udvendig gevind	28,-



Best. nr.	Artikelnummer	Tilslutning	Kr/stk
022302	22SF IW13 SXN	1/4" indvendig gevind	22,-
022304	22SF IW17 SXN	3/8" indvendig gevind	22,-
022305	22SF IW21 SXN	1/2" indvendig gevind	27,-

SERIE 23 - 1/4" industrikobling iht.

ISO 6150 B og US Mil. Spec. 4109. Forniklet udførelse. Flow 1000 ltr/min.



Best. nr.	Artikelnummer	Tilslutning	Kr/stk
023012	23KA AK13 MPN	1/4" udvendig gevind	113,-
023014	23KA AK17 MPN	3/8" udvendig gevind	113,-
023015	23KA AK21 MPN	1/2" udvendig gevind	117,-



Best. nr.	Artikelnummer	Tilslutning	Kr/stk
023002	23KA IW13 MPN	1/4" indvendig gevind	113,-
023004	23KA IW17 MPN	3/8" indvendig gevind	113,-
023005	23KA IW21 MPN	1/2" indvendig gevind	117,-



Best. nr.	Artikelnummer	Tilslutning	Kr/stk
023106	23KA TF06 MPN	6 mm slangestuds	112,-
023108	23KA TF08 MPN	8 mm slangestuds	112,-
023109	23KA TF09 MPN	9 mm slangestuds	112,-
023110	23KA TF10 MPN	10 mm slangestuds	113,-
023113	23KA TF13 MPN	13 mm slangestuds	113,-



Best. nr.	Artikelnummer	Tilslutning	Kr/stk
023204	23SF TF04 MXN	4 mm slangestuds	22,-
023206	23SF TF06 SXN	6 mm slangestuds	22,-
023208	23SF TF08 SXN	8 mm slangestuds	22,-
023209	23SF TF09 SXN	9 mm slangestuds	22,-
023210	23SF TF10 SXN	10 mm slangestuds	22,-
023213	23SF TF13 SXN	13 mm slangestuds	26,-



Best. nr.	Artikelnummer	Tilslutning	Kr/stk
023310	23SF AK10 SXN	1/8" udvendig gevind	22,-
023312	23SF AK13 SXN	1/4" udvendig gevind	23,-
023314	23SF AK17 SXN	3/8" udvendig gevind	27,-
023315	23SF AK21 SXN	1/2" udvendig gevind	42,-



Best. nr.	Artikelnummer	Tilslutning	Kr/stk
023300	23SF IW10 SXN	1/8" indvendig gevind	22,-
023302	23SF IW13 SXN	1/4" indvendig gevind	23,-
023304	23SF IW17 SXN	3/8" indvendig gevind	32,-
023305	23SF IW21 SXN	1/2" indvendig gevind	46,-

SERIE 26 - EUROSTANDARD profil.

Mange tilslutnings- & materiale muligheder. Flow 1150 ltr/min.



Best. nr.	Artikelnummer	Tilslutning	Kr/stk
026010	26KA AW10 MPX	1/8" udvendig gevind, Messing	63,-
026010N	26KA AW10 MPN	1/8" udvendig gevind, Forniklet	89,-
026012	26KA AW13 MPX	1/4" udvendig gevind, Messing	58,-
026012N	26KA AW13 MPN	1/4" udvendig gevind, Forniklet	89,-
026014	26KA AW17 MPX	3/8" udvendig gevind, Messing	58,-
026014N	26KA AW17 MPN	3/8" udvendig gevind, Forniklet	89,-
026015	26KA AW21 MPX	1/2" udvendig gevind, Messing	61,-
026015N	26KA AW21 MPN	1/2" udvendig gevind, Forniklet	91,-



Best. nr.	Artikelnummer	Tilslutning	Kr/stk
026002	26KA IW13 MPX	1/4" indvendig gevind, Messing	58,-
026002N	26KA IW13 MPN	1/4" indvendig gevind, Forniklet	89,-
026004	26KA IW17 MPX	3/8" indvendig gevind, Messing	58,-
026004N	26KA IW17 MPN	3/8" indvendig gevind, Forniklet	89,-
026005	26KA IW21 MPX	1/2" indvendig gevind, Messing	61,-
026005N	26KA IW21 MPN	1/2" indvendig gevind, Forniklet	91,-



Best. nr.	Artikelnummer	Tilslutning	Kr/stk
026106	26KA TF06 MPX	6 mm slangestuds, Messing	69,-
026106N	26KA TF06 MPN	6 mm slangestuds, Forniklet	101,-
026108	26KA TF08 MPX	8 mm slangestuds, Messing	69,-
026108N	26KA TF08 MPN	8 mm slangestuds, Forniklet	102,-
026109	26KA TF09 MPX	9 mm slangestuds, Messing	69,-
026109N	26KA TF09 MPN	9 mm slangestuds, Forniklet	102,-
026110	26KA TF10 MPX	10 mm slangestuds, Messing	71,-
026110N	26KA TF10 MPN	10 mm slangestuds, Forniklet	106,-
026113	26KA TF13 MPX	13 mm slangestuds, Messing	103,-
026113N	26KA TF13 MPN	13 mm slangestuds, Forniklet	109,-



Best. nr.	Artikelnummer	Tilslutning	Kr/stk
026136	26KA K006 MPX	4 x 6 mm klemstuds, Messing	88,-
026136N	26KA K006 MPN	4 x 6 mm klemstuds, Forniklet	120,-
026138	26KA K008 MPX	6 x 8 mm klemstuds, Messing	88,-
026138N	26KA K008 MPN	6 x 8 mm klemstuds, Forniklet	120,-
026130	26KA K010 MPX	8 x 10 mm klemstuds, Messing	86,-
026130N	26KA K010 MPN	8 x 10 mm klemstuds, Forniklet	120,-
026132	26KA K012 MPX	9 x 12 mm klemstuds, Messing	86,-
026132N	26KA K012 MPN	9 x 12 mm klemstuds, Forniklet	120,-



Best. nr.	Artikelnummer	Tilslutning	Kr/stk
026146	26KA TS06 MPX	6 mm slangestuds og skotgennemføring, M	125,-
026146N	26KA TS06 MPN	6 mm slangestuds og skotgennemføring, F	138,-
026148	26KA TS08 MPX	8 mm slangestuds og skotgennemføring, M	125,-
026148N	26KA TS08 MPN	8 mm slangestuds og skotgennemføring, F	138,-
026140	26KA TS10 MPX	10 mm slangestuds og skotgennemføring, M	129,-
026140N	26KA TS10 MPN	10 mm slangestuds og skotgennemføring, F	162,-



Best. nr.	Artikelnummer	Tilslutning	Kr/stk
026168	26KA KK08 MPX	6 x 8 mm klemstuds og aflastningsfjeder, M	104,-
026168N	26KA KK08 MPN	6 x 8 mm klemstuds og aflastningsfjeder, F	137,-
026160	26KA KK10 MPX	8 x 10 mm klemstuds og aflastningsfjeder, M	109,-
026160N	26KA KK10 MPN	8 x 10 mm klemstuds og aflastningsfjeder, F	144,-
026162	26KA KK12 MPX	9 x 12 mm klemstuds og aflastningsfjeder, M	113,-
026162N	26KA KK12 MPN	9 x 12 mm klemstuds og aflastningsfjeder, F	147,-



Best. nr.	Artikelnummer	Tilslutning	Kr/stk
026204	26SF TF04 MXX	4 mm slangestuds, Messing	18,-
026204N	26SF TF04 MXN	4 mm slangestuds, Forniklet	27,-
026206	26SF TF06 MXX	6 mm slangestuds, Messing	9,-
026206N	26SF TF06 MXN	6 mm slangestuds, Forniklet	21,-
026208	26SF TF08 MXX	8 mm slangestuds, Messing	9,-
026208N	26SF TF08 MXN	8 mm slangestuds, Forniklet	22,-
026209	26SF TF09 MXX	9 mm slangestuds, Messing	9,-
026209N	26SF TF09 MXN	9 mm slangestuds, Forniklet	18,-
026210	26SF TF10 MXX	10 mm slangestuds, Messing	13,-
026210N	126SF TF10 MXN	10 mm slangestuds, Forniklet	23,-
026213	26SF TF13 MXX	13 mm slangestuds, Messing	15,-
026213N	26SF TF13 MXN	13 mm slangestuds, Forniklet	25,-



Best. nr.	Artikelnummer	Tilslutning	Kr/stk
026336	26SF K006 MXX	4 x 6 mm klemstuds, Messing	20,-
026336N	26SF K006 MXN	4 x 6 mm klemstuds, Forniklet	30,-
026338	26SF K008 MXX	6 x 8 mm klemstuds, Messing	21,-
026338N	26SF K008 MXN	6 x 8 mm klemstuds, Forniklet	31,-
026330	26SF K010 MXX	8 x 10 mm klemstuds, Messing	31,-
026330N	26SF K010 MXN	8 x 10 mm klemstuds, Forniklet	46,-
026332	26SF K012 MXX	9 x 12 mm klemstuds, Messing	33,-
026332N	26SF K012 MXN	9 x 12 mm klemstuds, Forniklet	44,-



Best. nr.	Artikelnummer	Tilslutning	Kr/stk
026446	26SF TS06 MXX	6 mm slangestuds og skotgennemføring, M	46,-
026446N	26SF TS06 MXN	6 mm slangestuds og skotgennemføring, F	58,-
026448	26SF TS08 MXX	8 mm slangestuds og skotgennemføring, M	43,-
026448N	26SF TS08 MXN	8 mm slangestuds og skotgennemføring, F	58,-
026440	26SF TS10 MXX	10 mm slangestuds og skotgennemføring, M	44,-
026440N	26SF TS10 MXN	10 mm slangestuds og skotgennemføring, F	58,-



Best. nr.	Artikelnummer	Tilslutning	Kr/stk
026666	26SF KK06 MXX	4 x 6 mm klemstuds og aflastningsfjeder, M	40,-
026666N	26SF KK06 MXN	4 x 6 mm klemstuds og aflastningsfjeder, F	50,-
026668	26SF KK08 MXX	6 x 8 mm klemstuds og aflastningsfjeder, M	40,-
026668N	26SF KK08 MXN	6 x 8 mm klemstuds og aflastningsfjeder, F	50,-
026660	26SF KK10 MXX	8 x 10 mm klemstuds og aflastningsfjeder, M	46,-
026660N	26SF KK10 MXN	8 x 10 mm klemstuds og aflastningsfjeder, F	57,-
026662	26SF KK12 MXX	9 x 12 mm klemstuds og aflastningsfjeder, M	46,-
026662N	26SF KK12 MXN	9 x 12 mm klemstuds og aflastningsfjeder, F	57,-



Best. nr.	Artikelnummer	Tilslutning	Kr/stk
026310	26SF AW10 MXX	1/8" udvendig gevind, Messing	15,-
026310N	26SF AW10 MXN	1/8" udvendig gevind, Forniklet	25,-
026312	26SF AW12 MXX	1/4" udvendig gevind, Messing	15,-
026312N	26SF AW12 MXN	1/4" udvendig gevind, Forniklet	26,-
026314	26SF AW14 MXX	3/8" udvendig gevind, Messing	15,-
026314N	26SF AW14 MXN	3/8" udvendig gevind, Forniklet	26,-
026315	26SF AW17 MXX	1/2" udvendig gevind, Messing	24,-
026315N	26SF AW17 MXN	1/2" udvendig gevind, Forniklet	35,-



Best. nr.	Artikelnummer	Tilslutning	Kr/stk
026300	26SF IW10 MXX	1/8" indvendig gevind, Messing	15,-
026300N	26SF IW10 MXN	1/8" indvendig gevind, Forniklet	26,-
026302	26SF IW13 MXX	1/4" indvendig gevind, Messing	15,-
026302N	26SF IW13 MXN	1/4" indvendig gevind, Forniklet	26,-
026304	26SF IW17 MXX	3/8" indvendig gevind, Messing	15,-
026304N	26SF IW17 MXN	3/8" indvendig gevind, Forniklet	26,-
026305	26SF IW21 MXX	1/2" indvendig gevind, Messing	25,-
026305N	26SF IW21 MXN	1/2" indvendig gevind, Forniklet	35,-

SERIE 1625 - EUROSTANDARD profil. Premium industrikobling med ekstremt stort flow og nem til- & frakobling.

Robust 2-komponent termoplastisk hylse og QPQ hærdet ventil krop. Flow 2200 ltr/min.

SERIE 25 - EUROSTANDARD profil. Stort flow og en stærk og holdbar kobling. Forniklet udførelse. Flow 1800 ltr/min.



Best. nr.	Artikelnummer	Tilslutning	Kr/stk
01625002	1625KA IW13 SPN	1/4" indvendig gevind	91,-
01625004	1625KA IW17 SPN	3/8" indvendig gevind	91,-
01625005	1625KA IW21 SPN	1/2" indvendig gevind	97,-

Pakket på blister/SB kort

Best. nr.	Kr/stk
B1625002	95,-
B1625004	95,-
B1625005	101,-



Best. nr.	Artikelnummer	Tilslutning	Kr/stk
01625012	1625KA AK13 SPN	1/4" udvendig gevind	91,-
01625014	1625KA AK17 SPN	3/8" udvendig gevind	91,-
01625015	1625KA AK21 SPN	1/2" udvendig gevind	97,-

Pakket på blister/SB kort

Best. nr.	Kr/stk
B1625012	95,-
B1625014	95,-
B1625015	101,-



Best. nr.	Artikelnummer	Tilslutning	Kr/stk
01625106	1625KA TF06 SPN	6 mm slangestuds	91,-
01625108	1625KA TF08 SPN	8 mm slangestuds	91,-
01625109	1625KA TF09 SPN	9 mm slangestuds	91,-
01625110	1625KA TF10 SPN	10 mm slangestuds	91,-
01625113	1625KA TF13 SPN	13 mm slangestuds	97,-

Pakket på blister/SB kort

Best. nr.	Kr/stk
B1625106	95,-
B1625108	95,-
B1625109	95,-
B1625110	95,-
B1625113	101,-



Best. nr.	Artikelnummer	Tilslutning	Kr/stk
025002	25KA IW13 MPN	1/4" indvendig gevind	91,-
025004	25KA IW17 MPN	3/8" indvendig gevind	91,-
025005	25KA IW21 MPN	1/2" indvendig gevind	97,-

Pakket på blister/SB kort

Best. nr.	Kr/stk
B25002	95,-
B25004	95,-
B25005	101,-

Kan også leveres i rustfri udførelse AISI 303 eller AISI 316



Best. nr.	Artikelnummer	Tilslutning	Kr/stk
025012	25KA AK13 MPN	1/4" udvendig gevind	87,-
025014	25KA AK17 MPN	3/8" udvendig gevind	87,-
025015	25KA AK21 MPN	1/2" udvendig gevind	93,-

Pakket på blister/SB kort

Best. nr.	Kr/stk
B25012	91,-
B25014	91,-
B25015	97,-

Kan også leveres i rustfri udførelse AISI 303 eller AISI 316



Best. nr.	Artikelnummer	Tilslutning	Kr/stk
025106	25KA TF06 MPN	6 mm slangestuds	87,-
025108	25KA TF08 MPN	8 mm slangestuds	87,-
025109	25KA TF09 MPN	9 mm slangestuds	87,-
025110	25KA TF10 MPN	10 mm slangestuds	87,-
025113	25KA TF13 MPN	13 mm slangestuds	93,-

Pakket på blister/SB kort

Best. nr.	Kr/stk
B25106	91,-
B25108	91,-
B25109	91,-
B25110	91,-
B25113	97,-

Kan også leveres i rustfri udførelse AISI 303 eller AISI 316



Best. nr.	Tilslutning	Kr/stk
007002	1/4" indvendig gevind	76,-
007004	3/8" indvendig gevind	76,-
007005	1/2" indvendig gevind	76,-

Pakket på blister/SB kort

Best. nr.	Kr/stk
B07002	81,-
B07004	81,-
B07005	81,-



Best. nr.	Tilslutning	Kr/stk
007012	1/4" udvendig gevind	76,-
007014	3/8" udvendig gevind	76,-
007015	1/2" udvendig gevind	76,-

Pakket på blister/SB kort

Best. nr.	Kr/stk
B07012	81,-
B07014	81,-
B07015	81,-



Best. nr.	Tilslutning	Kr/stk
007106	6 mm slangestuds	76,-
007109	9 mm slangestuds	76,-
007113	13 mm slangestuds	76,-

Pakket på blister/SB kort

Best. nr.	Kr/stk
B07106	81,-
B07109	81,-
B07113	81,-



Best. nr.	Artikelnummer	Tilslutning	Kr/stk
025302	25SF IW13 SXZ	1/4" indvendig gevind	22,-
025304	25SF IW17 SXZ	3/8" indvendig gevind	22,-
025305	25SF IW21 SXZ	1/2" indvendig gevind	31,-

Pakket på blister/SB kort

Best. nr.	Kr/stk
B25302	26,-
B25304	26,-
B25305	35,-

Kan også leveres i rustfri udførelse AISI 303 eller AISI 316



Best. nr.	Artikelnummer	Tilslutning	Kr/stk
025312	25SF AK13 SXZ	1/4" udvendig gevind	21,-
025314	25SF AK17 SXZ	3/8" udvendig gevind	22,-
025315	25SF AK21 SXZ	1/2" udvendig gevind	29,-

Pakket på blister/SB kort

Best. nr.	Kr/stk
B25312	25,-
B25314	26,-
B25315	33,-

Kan også leveres i rustfri udførelse AISI 303 eller AISI 316



Best. nr.	Artikelnummer	Tilslutning	Kr/stk
025206	25SF TF06 SXZ	6 mm slangestuds	19,-
025208	25SF TF08 SXZ	8 mm slangestuds	20,-
025209	25SF TF09 SXZ	9 mm slangestuds	21,-
025210	25SF TF10 SXZ	10 mm slangestuds	22,-
025213	25SF TF13 SXZ	13 mm slangestuds	30,-

Pakket på blister/SB kort

Best. nr.	Kr/stk
B25206	24,-
B25208	24,-
B25209	25,-
B25210	26,-
B25213	34,-

Kan også leveres i rustfri udførelse AISI 303 eller AISI 316

SERIE 009 - EUROSTANDARD profil. Sikkerhedskobling med trykknop. 1 tryk, 1 teknologi, 1 serie. Ekstrem nem og sikker til- & frakobling blot ved ét tryk. Automatisk udluftning ved frakobling. Heavy-duty kompositte materiale, antistatisk, ultra lav vægt og stort flow. Flow 2100 ltr/min.



Best. nr.	Artikelnummer	Tilslutning	Kr/stk
009002	ESI 071101	1/4" indvendig gevind	177,-
009004	ESI 071102	3/8" indvendig gevind	182,-
009005	ESI 071103	1/2" indvendig gevind	186,-

Pakket på blister/SB kort

Best. nr.	Kr/stk
B09002	181,-
B09004	186,-
B09005	191,-



Best. nr.	Artikelnummer	Tilslutning	Kr/stk
009012	ESI 071151	1/4" udvendig gevind	177,-
009014	ESI 071152	3/8" udvendig gevind	182,-
009015	ESI 071153	1/2" udvendig gevind	186,-

Pakket på blister/SB kort

Best. nr.	Kr/stk
B09012	181,-
B09014	186,-
B09015	191,-



Best. nr.	Artikelnummer	Tilslutning	Kr/stk
009106	ESI 071806	6 mm slangestuds	186,-
009108	ESI 071808	8 mm slangestuds	186,-
009109	ESI 071809	9 mm slangestuds	186,-
009110	ESI 071810	10 mm slangestuds	186,-
009113	ESI 071813	13 mm slangestuds	186,-

Pakket på blister/SB kort

Best. nr.	Kr/stk
B09106	191,-
B09108	191,-
B09109	191,-
B09110	191,-
B09113	191,-



Best. nr.	Artikelnummer	Tilslutning	Kr/stk
025302	25SF IW13 SXZ	1/4" indvendig gevind	22,-
025304	25SF IW17 SXZ	3/8" indvendig gevind	22,-
025305	25SF IW21 SXZ	1/2" indvendig gevind	31,-

Pakket på blister/SB kort

Best. nr.	Kr/stk
B25302	26,-
B25304	26,-
B25305	35,-

Kan også leveres i rustfri udførelse AISI 303 eller AISI 316



Best. nr.	Artikelnummer	Tilslutning	Kr/stk
025312	25SF AK13 SXZ	1/4" udvendig gevind	21,-
025314	25SF AK17 SXZ	3/8" udvendig gevind	22,-
025315	25SF AK21 SXZ	1/2" udvendig gevind	29,-

Pakket på blister/SB kort

Best. nr.	Kr/stk
B25312	25,-
B25314	26,-
B25315	33,-

Kan også leveres i rustfri udførelse AISI 303 eller AISI 316



Best. nr.	Artikelnummer	Tilslutning	Kr/stk
025206	25SF TF06 SXZ	6 mm slangestuds	19,-
025208	25SF TF08 SXZ	8 mm slangestuds	20,-
025209	25SF TF09 SXZ	9 mm slangestuds	21,-
025210	25SF TF10 SXZ	10 mm slangestuds	22,-
025213	25SF TF13 SXZ	13 mm slangestuds	30,-

Pakket på blister/SB kort

Best. nr.	Kr/stk
B25206	24,-
B25208	24,-
B25209	25,-
B25210	26,-
B25213	34,-

Kan også leveres i rustfri udførelse AISI 303 eller AISI 316



Best. nr.	Tilslutning	Kr/stk
682525	Y-stykke med koblingsnippel og 2 lynkoblinger 025014	249,-



Best. nr.	Tilslutning	Kr/stk
681625	Y-stykke med koblingsnippel og 2 lynkoblinger 01625014	253,-



Best. nr.	Tilslutning	Kr/stk
680909	Y-stykke med koblingsnippel og 2 sikkerhedskoblinger 009014	458,-

UDLUFTNINGSNIPPEL/FLEX NIPPEL



Best. nr.	Tilslutning	Kr/stk
025906	6 mm slangestuds	68,-
025908	8 mm slangestuds	68,-
025909	9 mm slangestuds	68,-
025910	10 mm slangestuds	69,-
025913	13 mm slangestuds	72,-
T162105	1/4" udvendig gevind	70,-



Best. nr.	Tilslutning	Kr/stk
401202	Flexnippel 1/4" indvendig x 1/4" udvendig	224,-
441202	Kuglenippel 1/4" indvendig x 1/4" udvendig	101,-
443312	Kuglenippel 1/4" koblingsnp. x 1/4" udvendig	101,-
442212	Kuglenippel 1/4" slangestuds x 1/4" udvendig	101,-

SERIE 27 - 1/2" EUROSTANDARD profil kompatibel med Cejn serie 410, Tema 1700. Forniklet udførelse. Flow 2400 ltr/min.

SERIE 1727 - Samme profil men med ekstrem høj flowkapacitet, nem til- & frakobling og 2-komponent termoplastisk hylse.

Flow 3700 ltr/min.



Best. nr.	Artikelnummer	Tilslutning	Kr/stk
027012	27KA AK13 MPN	1/4" udvendig gevind	248,-
027014	27KA AK17 MPN	3/8" udvendig gevind	248,-
027015	27KA AK21 MPN	1/2" udvendig gevind	261,-
027017	27KA AK26 MPN	3/4" udvendig gevind	261,-
01727014	1727KA AK17 SPN	3/8" udvendig gevind	197,-
01727015	1727KA AK21 SPN	1/2" udvendig gevind	212,-
01727017	1727KA AK26 SPN	3/4" udvendig gevind	212,-



Best. nr.	Artikelnummer	Tilslutning	Kr/stk
027002	27KA IW13 MPN	1/4" indvendig gevind	248,-
027004	27KA IW17 MPN	3/8" indvendig gevind	248,-
027005	27KA IW21 MPN	1/2" indvendig gevind	261,-
027007	27KA IW26 MPN	3/4" indvendig gevind	261,-
01727004	1727KA IW10 SPN	3/8" indvendig gevind	197,-
01727005	1727KA IW13 SPN	1/2" indvendig gevind	197,-
01727007	1727KA IW19 SPN	3/4" indvendig gevind	215,-



Best. nr.	Artikelnummer	Tilslutning	Kr/stk
027108	27KA TF08 MPN	8 mm slangestuds	248,-
027110	27KA TF10 MPN	10 mm slangestuds	248,-
027113	27KA TF13 MPN	13 mm slangestuds	248,-
027119	27KA TF19 MPN	19 mm slangestuds	248,-
01727110	1727KA TF10 SPN	10 mm slangestuds	197,-
01727113	1727KA TF13 SPN	13 mm slangestuds	197,-
01727119	1727KA TF19 SPN	19 mm slangestuds	197,-



Best. nr.	Artikelnummer	Tilslutning	Kr/stk
027206	27KA TF06 SXN	6 mm slangestuds	43,-
027208	27KA TF08 SXN	8 mm slangestuds	43,-
027209	27KA TF09 SXN	9 mm slangestuds	43,-
027210	27KA TF10 SXN	10 mm slangestuds	40,-
027213	27KA TF13 SXN	13 mm slangestuds	40,-
027216	27KA TF16 SXN	16 mm slangestuds	46,-
027219	27KA TF19 SXN	19 mm slangestuds	59,-



Best. nr.	Artikelnummer	Tilslutning	Kr/stk
027312	27SF AK13 SXN	1/4" udvendig gevind	49,-
027314	27SF AK17 SXN	3/8" udvendig gevind	43,-
027315	27SF AK21 SXN	1/2" udvendig gevind	51,-
027317	27SF AK26 SXN	3/4" udvendig gevind	97,-



Best. nr.	Artikelnummer	Tilslutning	Kr/stk
027302	27SF IW13 SXN	1/4" indvendig gevind	49,-
027304	27SF IW17 SXN	3/8" indvendig gevind	49,-
027305	27SF IW21 SXN	1/2" indvendig gevind	53,-
027307	27SF IW26 SXN	3/4" indvendig gevind	97,-



Best. nr.	Artikelnummer	Tilslutning	Kr/stk
033012	33KA AK13 SPN	1/4" udvendig gevind	126,-
033014	33KA AK17 SPN	3/8" udvendig gevind	126,-
033015	33KA AK21 SPN	1/2" udvendig gevind	134,-



Best. nr.	Artikelnummer	Tilslutning	Kr/stk
033002	33KA IW13 SPN	1/4" indvendig gevind	126,-
033004	33KA IW17 SPN	3/8" indvendig gevind	126,-
033005	33KA IW21 SPN	1/2" indvendig gevind	134,-



Best. nr.	Artikelnummer	Tilslutning	Kr/stk
033106	33KA TF06 SPN	6 mm slangestuds	126,-
033108	33KA TF08 SPN	8 mm slangestuds	126,-
033110	33KA TF10 SPN	10 mm slangestuds	126,-
033113	33KA TF13 SPN	13 mm slangestuds	126,-



Best. nr.	Artikelnummer	Tilslutning	Kr/stk
033206	33SF TF06 SXN	6 mm slangestuds	27,-
033208	33SF TF08 SXN	8 mm slangestuds	27,-
033210	33SF TF10 SXN	10 mm slangestuds	27,-
033213	33SF TF13 SXN	13 mm slangestuds	28,-



Best. nr.	Artikelnummer	Tilslutning	Kr/stk
033310	33SF AK10 SXN	1/8" udvendig gevind	27,-
033312	33SF AK13 SXN	1/4" udvendig gevind	27,-
033314	33SF AK17 SXN	3/8" udvendig gevind	27,-
033315	33SF AK21 SXN	1/2" udvendig gevind	44,-



Best. nr.	Artikelnummer	Tilslutning	Kr/stk
033300	33SF IW10 SXN	1/8" indvendig gevind	27,-
033302	33SF IW13 SXN	1/4" indvendig gevind	27,-
033304	33SF IW17 SXN	3/8" indvendig gevind	27,-
033305	33SF IW21 SXN	1/2" indvendig gevind	42,-



Best. nr.	Artikelnummer	Tilslutning	Kr/stk
034012	34KA AK13 SPN	1/4" udvendig gevind	190,-
034014	34KA AK17 SPN	3/8" udvendig gevind	190,-
034015	34KA AK21 SPN	1/2" udvendig gevind	190,-
034017	34KA AK24 SPN	3/4" udvendig gevind	221,-



Best. nr.	Artikelnummer	Tilslutning	Kr/stk
034002	34KA IW13 SPN	1/4" indvendig gevind	190,-
034004	34KA IW17 SPN	3/8" indvendig gevind	190,-
034005	34KA IW21 SPN	1/2" indvendig gevind	190,-
034007	34KA IW26 SPN	3/4" indvendig gevind	221,-



Best. nr.	Artikelnummer	Tilslutning	Kr/stk
034106	34KA TF06 SPN	6 mm slangestuds	190,-
034108	34KA TF08 SPN	8 mm slangestuds	190,-
034110	34KA TF10 SPN	10 mm slangestuds	190,-
034113	34KA TF13 SPN	13 mm slangestuds	190,-
034116	34KA TF16 SPN	16 mm slangestuds	190,-
034119	34KA TF19 SPN	19 mm slangestuds	224,-



Best. nr.	Artikelnummer	Tilslutning	Kr/stk
034206	34SF TF06 SXN	6 mm slangestuds	30,-
034210	34SF TF10 SXN	10 mm slangestuds	30,-
034213	34SF TF13 SXN	13 mm slangestuds	30,-
034216	34SF TF16 SXN	16 mm slangestuds	30,-



Best. nr.	Artikelnummer	Tilslutning	Kr/stk
034312	34SF AK13 SXN	1/4" udvendig gevind	30,-
034314	34SF AK17 SXN	3/8" udvendig gevind	30,-
034315	34SF AK21 SXN	1/2" udvendig gevind	30,-



Best. nr.	Artikelnummer	Tilslutning	Kr/stk
034302	34SF IW13 SXN	1/4" indvendig gevind	29,-
034304	34SF IW17 SXN	3/8" indvendig gevind	29,-
034305	34SF IW21 SXN	1/2" indvendig gevind	29,-



Best. nr.	Artikelnummer	Tilslutning	Kr/stk
O50000	50000A9	1/4" indvendig gevind	175,-



Best. nr.	Artikelnummer	Tilslutning	Kr/stk
O50001	50001A9	1/4" udvendig gevind	181,-



Best. nr.	Artikelnummer	Tilslutning	Kr/stk
O50005	50005A9	6 mm slangestuds	189,-



Best. nr.	Artikelnummer	Tilslutning	Kr/stk
O50040	50040A9	6 mm slangestuds	35,-



Best. nr.	Artikelnummer	Tilslutning	Kr/stk
O51521	51521A9	1/4" udvendig gevind	53,-



Best. nr.	Artikelnummer	Tilslutning	Kr/stk
O51520	51520A9	1/4" indvendig gevind	50,-

SERIE 21KB - Mini industrikobling med ventil i både kobling og nippel delen.

Lille kobling med høj luftgennemstrømning. Mange tilslutnings- & materiale muligheder. Flow 180 ltr/min.



Best. nr.	Artikelnummer	Tilslutning	Kr/stk
021010KB	21KB AW10 MPX	1/8" udvendig gevind, Messing	91,-
021010KBN	21KB AW10 MPN	1/8" udvendig gevind, Forniklet	117,-
021012KB	21KB AW13 MPX	1/4" udvendig gevind, Messing	91,-
021012KBN	21KB AW13 MPN	1/4" udvendig gevind, Forniklet	117,-
021014KB	21KB AW17 MPX	3/8" udvendig gevind, Messing	98,-
021014KBN	21KB AW17 MPN	3/8" udvendig gevind, Forniklet	124,-



Best. nr.	Artikelnummer	Tilslutning	Kr/stk
021000KB	21KB IW10 MPX	1/8" indvendig gevind, Messing	91,-
021000KBN	21KB IW10 MPN	1/8" indvendig gevind, Forniklet	117,-
021002KB	21KB IW13 MPX	1/4" indvendig gevind, Messing	91,-
021002KBN	21KB IW13 MPN	1/4" indvendig gevind, Forniklet	117,-
021004KB	21KB IW17 MPX	3/8" indvendig gevind, Messing	98,-
021004KBN	21KB IW17 MPN	3/8" indvendig gevind, Forniklet	124,-



Best. nr.	Artikelnummer	Tilslutning	Kr/stk
021104KB	21KB TF04 MPX	4 mm slangestuds, Messing	10,-
021104KBN	21KB TF04 MPN	4 mm slangestuds, Forniklet	126,-
021105KB	21KB TF05 MPX	5 mm slangestuds, Messing	101,-
021105KBN	21KB TF05 MPN	5 mm slangestuds, Forniklet	125,-
021106KB	21KB TF06 MPX	6 mm slangestuds, Messing	100,-
021106KBN	21KB TF06 MPN	6 mm slangestuds, Forniklet	125,-
021108KB	21KB TF08 MPX	8 mm slangestuds, Messing	102,-
021108KBN	21KB TF08 MPN	8 mm slangestuds, Forniklet	128,-
021109KB	21KB TF09 MPX	9 mm slangestuds, Messing	102,-
021109KBN	21KB TF09 MPN	9 mm slangestuds, Forniklet	128,-
021110KB	21KB TF10 MPX	10 mm slangestuds, Messing	103,-
021110KBN	21KB TF10 MPN	10 mm slangestuds, Forniklet	129,-



Best. nr.	Artikelnummer	Tilslutning	Kr/stk
021136KB	21KB K006 MPX	4 x 6 mm klemstuds, Messing	110,-
021136KBN	21KB K006 MPN	4 x 6 mm klemstuds, Forniklet	134,-
021138KB	21KB K008 MPX	6 x 8 mm klemstuds, Messing	91,-
021138KBN	21KB K008 MPN	6 x 8 mm klemstuds, Forniklet	134,-



Best. nr.	Artikelnummer	Tilslutning	Kr/stk
021156KB	21KB KS06 MPX	4 x 6 mm klemstuds og skotgennemføring, M	147,-
021156KBN	21KB KS06 MPN	4 x 6 mm klemstuds og skotgennemføring, F	172,-
021158KB	21KB KS08 MPX	6 x 8 mm klemstuds og skotgennemføring, M	148,-
021158KBN	21KB KS08 MPN	6 x 8 mm klemstuds og skotgennemføring, F	172,-



Best. nr.	Artikelnummer	Tilslutning	Kr/stk
021144KB	21KB TS04 MPX	4 mm slangestuds og skotgennemføring, M	154,-
021144KBN	21KB TS04 MPN	4 mm slangestuds og skotgennemføring, F	179,-
021145KB	21KB TS05 MPX	5 mm slangestuds og skotgennemføring, M	149,-
021145KBN	21KB TS05 MPN	5 mm slangestuds og skotgennemføring, F	173,-
021146KB	21KB TS06 MPX	6 mm slangestuds og skotgennemføring, M	148,-
021146KBN	21KB TS06 MPN	6 mm slangestuds og skotgennemføring, F	172,-
021148KB	21KB TS08 MPX	8 mm slangestuds og skotgennemføring, M	169,-
021148KBN	21KB TS08 MPN	8 mm slangestuds og skotgennemføring, F	194,-
021140KB	21KB TS10 MPX	10 mm slangestuds og skotgennemføring, M	172,-
021140KBN	21KB TS10 MPN	10 mm slangestuds og skotgennemføring, F	194,-



Best. nr.	Artikelnummer	Tilslutning	Kr/stk
	21KB KK06 MPX	4 x 6 mm klemstuds og aflastningsfjeder, M	134,-
	21KB KK06 MPN	4 x 6 mm klemstuds og aflastningsfjeder, F	160,-
	21KB KK08 MPX	6 x 8 mm klemstuds og aflastningsfjeder, M	134,-
	21KB KK08 MPN	6 x 8 mm klemstuds og aflastningsfjeder, F	160,-



Best. nr.	Artikelnummer	Tilslutning	Kr/stk
021204SB	21SB TF04 MPX	4 mm slangestuds, Messing	88,-
021204SBN	21SB TF04 MPN	4 mm slangestuds, Forniklet	106,-
021205SB	21SB TF05 MPX	5 mm slangestuds, Messing	83,-
021205SBN	21SB TF05 MPN	5 mm slangestuds, Forniklet	102,-
021206SB	21SB TF06 MPX	6 mm slangestuds, Messing	88,-
021206SBN	21SB TF06 MPN	6 mm slangestuds, Forniklet	106,-
021208SB	21SB TF08 MPX	8 mm slangestuds, Messing	91,-
021208SBN	21SB TF08 MPN	8 mm slangestuds, Forniklet	107,-
021209SB	21SB TF09 MPX	9 mm slangestuds, Messing	91,-
021209SBN	21SB TF09 MPN	9 mm slangestuds, Forniklet	107,-
021210SB	21SB TF10 MPX	10 mm slangestuds, Messing	93,-
021210SBN	21SB TF10 MPN	10 mm slangestuds, Forniklet	111,-



Best. nr.	Artikelnummer	Tilslutning	Kr/stk
021336SB	21SB K006 MPX	4 x 6 mm klemstuds, Messing	91,-
021336SBN	21SB K006 MPN	4 x 6 mm klemstuds, Forniklet	107,-
021338SB	21SB K008 MPX	6 x 8 mm klemstuds, Messing	91,-
021338SBN	21SB K008 MPN	6 x 8 mm klemstuds, Forniklet	107,-



Best. nr.	Artikelnummer	Tilslutning	Kr/stk
021556SB	21SB KS06 MPX	4 x 6 mm klemstuds og skotgennemføring, M	148,-
021556SBN	21SB KS06 MPN	4 x 6 mm klemstuds og skotgennemføring, F	168,-
021558SB	21SB KS08 MPX	6 x 8 mm klemstuds og skotgennemføring, M	148,-
021558SBN	21SB KS08 MPN	6 x 8 mm klemstuds og skotgennemføring, F	168,-



Best. nr.	Artikelnummer	Tilslutning	Kr/stk
021444SB	21SB TS04 MPX	4 mm slangestuds og skotgennemføring, M	138,-
021444SBN	21SB TS04 MPN	4 mm slangestuds og skotgennemføring, F	154,-
021445SB	21SB TS05 MPX	5 mm slangestuds og skotgennemføring, M	134,-
021445SBN	21SB TS05 MPN	5 mm slangestuds og skotgennemføring, F	154,-
021446SB	21SB TS06 MPX	6 mm slangestuds og skotgennemføring, M	138,-
021446SBN	21SB TS06 MPN	6 mm slangestuds og skotgennemføring, F	154,-
021448SB	21SB TS08 MPX	8 mm slangestuds og skotgennemføring, M	163,-
021448SBN	21SB TS08 MPN	8 mm slangestuds og skotgennemføring, F	179,-
021449SB	21SB TS09 MPX	9 mm slangestuds og skotgennemføring, M	163,-
021449SBN	21SB TS09 MPN	9 mm slangestuds og skotgennemføring, F	179,-
021440SB	21SB TS10 MPX	10 mm slangestuds og skotgennemføring, M	163,-
021440SBN	21SB TS10 MPN	10 mm slangestuds og skotgennemføring, F	179,-

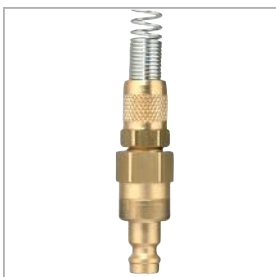

Best. nr.	Artikelnummer	Tilslutning	Kr/stk
	21SB KK06 MPX	4 x 6 mm klemstuds og aflastningsfjeder, M	112,-
	21SB KK06 MPN	4 x 6 mm klemstuds og aflastningsfjeder, F	128,-
	21SB KK08 MPX	6 x 8 mm klemstuds og aflastningsfjeder, M	112,-
	21SB KK08 MPN	6 x 8 mm klemstuds og aflastningsfjeder, F	128,-

SERIE 21KB - Mini industrikobling med ventil i både kobling og nippel delen.

Lille kobling med høj luftgennemstrømning. Mange tilslutnings- & materiale muligheder



Best. nr.	Artikelnummer	Tilslutning	Kr/stk
021310SB	21SB AW10 MPX	1/8" udvendig gevind, Messing	70,-
021310SBN	21SB AW10 MPN	1/8" udvendig gevind, Forniklet	87,-
021312SB	21SB AW13 MPX	1/4" udvendig gevind, Messing	70,-
021312SBN	21SB AW13 MPN	1/4" udvendig gevind, Forniklet	88,-
021314SB	21SB AW17 MPX	3/8" udvendig gevind, Messing	93,-
021314SBN	21SB AW17 MPN	3/8" udvendig gevind, Forniklet	111,-

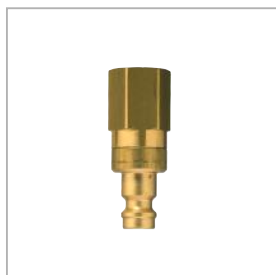

Best. nr.	Artikelnummer	Tilslutning	Kr/stk
021300SB	21SB IW10 MPX	1/8" indvendig gevind, Messing	70,-
021300SBN	21SB IW10 MPN	1/8" indvendig gevind, Forniklet	87,-
021302SB	21SB IW13 MPX	1/4" indvendig gevind, Messing	70,-
021302SBN	21SB IW13 MPN	1/4" indvendig gevind, Forniklet	87,-
021304SB	21SB IW17 MPX	3/8" indvendig gevind, Messing	93,-
021304SBN	21SB IW17 MPN	3/8" indvendig gevind, Forniklet	111,-



Lynkoblinger fra **RECTUS** og **TEMA** til lav-, mellem- og højtryk
i mange forskellige design og kvaliteter.

SERIE 26KB - EUROSTANDARD profil med ventil i både kobling og nippel delen.

Mange tilslutnings- & materiale muligheder. Se nipler på side 29. Flow 650 ltr/min.



Best. nr.	Artikelnummer	Tilslutning	Kr/stk
026010KB	26KB AW10 MPX	1/8" udvendig gevind, Messing	90,-
026010KBN	26KB AW10 MPN	1/8" udvendig gevind, Forniklet	119,-
026012KB	26KB AW13 MPX	1/4" udvendig gevind, Messing	111,-
026012KBN	26KB AW13 MPN	1/4" udvendig gevind, Forniklet	116,-
026014KB	26KB AW17 MPX	3/8" udvendig gevind, Messing	90,-
026014KBN	26KB AW17 MPN	3/8" udvendig gevind, Forniklet	130,-
026015KB	26KB AW21 MPX	1/2" udvendig gevind, Messing	90,-
026015KBN	26KB AW21 MPN	1/2" udvendig gevind, Forniklet	117,-



Best. nr.	Artikelnummer	Tilslutning	Kr/stk
026002KB	26KB IW13 MPX	1/4" indvendig gevind, Messing	90,-
026002KBN	26KB IW13 MPN	1/4" indvendig gevind, Forniklet	116,-
026004KB	26KB IW17 MPX	3/8" indvendig gevind, Messing	88,-
026004KBN	26KB IW17 MPN	3/8" indvendig gevind, Forniklet	116,-
026005KB	26KB IW21 MPX	1/2" indvendig gevind, Messing	90,-
026005KBN	26KB IW21 MPN	1/2" indvendig gevind, Forniklet	117,-



Best. nr.	Artikelnummer	Tilslutning	Kr/stk
026106KB	26KB TF06 MPX	6 mm slangestuds, Messing	98,-
026106KBN	26KB TF06 MPN	6 mm slangestuds, Forniklet	126,-
026108KB	26KB TF08 MPX	8 mm slangestuds, Messing	98,-
026108KBN	26KB TF08 MPN	8 mm slangestuds, Forniklet	126,-
026109KB	26KB TF09 MPX	9 mm slangestuds, Messing	98,-
026109KBN	26KB TF09 MPN	9 mm slangestuds, Forniklet	126,-
026110KB	26KB TF10 MPX	10 mm slangestuds, Messing	106,-
026110KBN	26KB TF10 MPN	10 mm slangestuds, Forniklet	127,-
026113KB	26KB TF13 MPX	13 mm slangestuds, Messing	106,-
026113KBN	26KB TF13 MPN	13 mm slangestuds, Forniklet	134,-



Best. nr.	Artikelnummer	Tilslutning	Kr/stk
026138KB	26KB K008 MPX	6 x 8 mm klemstuds, Messing	117,-
026138KBN	26KB K008 MPN	6 x 8 mm klemstuds, Forniklet	142,-
026130KB	26KB K010 MPX	8 x 10 mm klemstuds, Messing	117,-
026130KBN	26KB K010 MPN	8 x 10 mm klemstuds, Forniklet	142,-
026132KB	26KB K012 MPX	9 x 12 mm klemstuds, Messing	117,-
026132KBN	26KB K012 MPN	9 x 12 mm klemstuds, Forniklet	142,-



Best. nr.	Artikelnummer	Tilslutning	Kr/stk
026146KB	26KB TS06 MPX	6 mm slangestuds og skotgennemføring, M	148,-
026146KBN	26KB TS06 MPN	6 mm slangestuds og skotgennemføring, F	175,-
026148KB	26KB TS08 MPX	8 mm slangestuds og skotgennemføring, M	148,-
026148KBN	26KB TS08 MPN	8 mm slangestuds og skotgennemføring, F	175,-
026140KB	26KB TS10 MPX	10 mm slangestuds og skotgennemføring, M	150,-
026140KBN	26KB TS10 MPN	10 mm slangestuds og skotgennemføring, F	176,-



Best. nr.	Artikelnummer	Tilslutning	Kr/stk
	26KB KK08 MPX	6 x 8 mm klemstuds og aflastningsfjeder, M	135,-
	26KB KK08 MPN	6 x 8 mm klemstuds og aflastningsfjeder, F	162,-
	26KB KK10 MPX	8 x 10 mm klemstuds og aflastningsfjeder, M	139,-
	26KB KK10 MPN	8 x 10 mm klemstuds og aflastningsfjeder, F	168,-
	26KB KK12 MPX	9 x 12 mm klemstuds og aflastningsfjeder, M	144,-
	26KB KK12 MPN	9 x 12 mm klemstuds og aflastningsfjeder, F	172,-

SERIE 25KB - EUROSTANDARD profil med ventil i både kobling og nippel delen.

Stort flow og en stærk og holdbar kobling. Flow 700 ltr/min.



Best. nr.	Artikelnummer	Tilslutning	Kr/stk
025012KB	25KB AK13 BPX	1/4" udvendig gevind, Messing	218,-
025012KBN	25KB AK13 BPN	1/4" udvendig gevind, Forniklet	245,-
025014KB	25KB AK17 BPX	3/8" udvendig gevind, Messing	228,-
025014KBN	25KB AK17 BPN	3/8" udvendig gevind, Forniklet	245,-
025015KB	25KB AK21 BPX	1/2" udvendig gevind, Messing	228,-
025015KBN	25KB AK21 BPN	1/2" udvendig gevind, Forniklet	254,-



Best. nr.	Artikelnummer	Tilslutning	Kr/stk
025002KB	25KB IW13 BPX	1/4" indvendig gevind, Messing	218,-
025002KBN	25KB IW13 BPN	1/4" indvendig gevind, Forniklet	245,-
025004KB	25KB IW17 BPX	3/8" indvendig gevind, Messing	218,-
025004KBN	25KB IW17 BPN	3/8" indvendig gevind, Forniklet	245,-
025005KB	25KB IW21 BPX	1/2" indvendig gevind, Messing	228,-
025005KBN	25KB IW21 BPN	1/2" indvendig gevind, Forniklet	254,-



Best. nr.	Artikelnummer	Tilslutning	Kr/stk
025106KB	25KB TF06 BPX	6 mm slangestuds, Messing	218,-
025106KBN	25KB TF06 BPN	6 mm slangestuds, Forniklet	245,-
025108KB	25KB TF08 BPX	8 mm slangestuds, Messing	218,-
025108KBN	25KB TF08 BPN	8 mm slangestuds, Forniklet	245,-
025109KB	25KB TF09 BPX	9 mm slangestuds, Messing	218,-
025109KBN	25KB TF09 BPN	9 mm slangestuds, Forniklet	245,-
025110KB	25KB TF10 BPX	10 mm slangestuds, Messing	218,-
025110KBN	25KB TF10 BPN	10 mm slangestuds, Forniklet	245,-
025113KB	25KB TF13 BPX	13 mm slangestuds, Messing	225,-
025113KBN	25KB TF13 BPN	13 mm slangestuds, Forniklet	250,-



Best. nr.	Artikelnummer	Tilslutning	Kr/stk
025138KB	25KB K008 BPX	6 x 8 mm klemstuds, Messing	237,-
025138KBN	25KB K008 BPN	6 x 8 mm klemstuds, Forniklet	266,-
025130KB	25KB K010 BPX	8 x 10 mm klemstuds, Messing	237,-
025130KBN	25KB K010 BPN	8 x 10 mm klemstuds, Forniklet	266,-
025132KB	25KB K012 BPX	9 x 12 mm klemstuds, Messing	237,-
025132KBN	25KB K012 BPN	9 x 12 mm klemstuds, Forniklet	266,-



Best. nr.	Artikelnummer	Tilslutning	Kr/stk
025146KB	25KB TS06 BPX	6 mm slangestuds og skotgennemføring, M	269,-
025146KBN	25KB TS06 BPN	6 mm slangestuds og skotgennemføring, F	294,-
025148KB	25KB TS08 BPX	8 mm slangestuds og skotgennemføring, M	269,-
025148KBN	25KB TS08 BPN	8 mm slangestuds og skotgennemføring, F	294,-
025140KB	25KB TS10 BPX	10 mm slangestuds og skotgennemføring, M	269,-
025140KBN	25KB TS10 BPN	10 mm slangestuds og skotgennemføring, F	294,-



Best. nr.	Artikelnummer	Tilslutning	Kr/stk
	25KB KK08 MPX	6 x 8 mm klemstuds og aflastningsfjeder, M	267,-
	25KB KK08 MPN	6 x 8 mm klemstuds og aflastningsfjeder, F	294,-
	25KB KK10 MPX	8 x 10 mm klemstuds og aflastningsfjeder, M	267,-
	25KB KK10 MPN	8 x 10 mm klemstuds og aflastningsfjeder, F	294,-
	25KB KK12 MPX	9 x 12 mm klemstuds og aflastningsfjeder, M	273,-
	25KB KK12 MPN	9 x 12 mm klemstuds og aflastningsfjeder, F	298,-



Best. nr.	Artikelnummer	Tilslutning	Kr/stk
	25SB TF06 MPX	6 mm slangestuds, Messing	95,-
	25SB TF06 MPN	6 mm slangestuds, Forniklet	113,-
	25SB TF08 MPX	8 mm slangestuds, Messing	95,-
025208SB	25SB TF08 MPN	8 mm slangestuds, Forniklet	113,-
	25SB TF09 MPX	9 mm slangestuds, Messing	95,-
	25SB TF09 MPN	9 mm slangestuds, Forniklet	113,-
	25SB TF10 MPX	10 mm slangestuds, Messing	95,-
025210SBN	25SB TF10 MPN	10 mm slangestuds, Forniklet	122,-
025213SB	25SB TF13 MPX	13 mm slangestuds, Messing	101,-
025213SBN	25SB TF13 MPN	13 mm slangestuds, Forniklet	119,-



Best. nr.	Artikelnummer	Tilslutning	Kr/stk
	25SB K006 MPX	4 x 6 mm klemstuds, Messing	107,-
	25SB K006 MPN	4 x 6 mm klemstuds, Forniklet	128,-
	25SB K008 MPX	6 x 8 mm klemstuds, Messing	107,-
	25SB K008 MPN	6 x 8 mm klemstuds, Forniklet	128,-
	25SB K010 MPX	8 x 10 mm klemstuds, Messing	116,-
	25SB K010 MPN	8 x 10 mm klemstuds, Forniklet	134,-
	25SB K013 MPX	9 x 12 mm klemstuds, Messing	116,-
	25SB K013 MPN	9 x 12 mm klemstuds, Forniklet	134,-



Best. nr.	Artikelnummer	Tilslutning	Kr/stk
	25SB TS06 MPX	6 mm slangestuds og skotgennemføring, M	144,-
	25SB TS06 MPN	6 mm slangestuds og skotgennemføring, F	164,-
	25SB TS08 MPX	8 mm slangestuds og skotgennemføring, M	144,-
	25SB TS08 MPN	8 mm slangestuds og skotgennemføring, F	164,-
	25SB TS10 MPX	10 mm slangestuds og skotgennemføring, M	144,-
	25SB TS10 MPN	10 mm slangestuds og skotgennemføring, F	164,-



Best. nr.	Artikelnummer	Tilslutning	Kr/stk
	25SB KK06 MPX	4 x 6 mm klemstuds og aflastningsfjeder, M	132,-
	25SB KK06 MPN	4 x 6 mm klemstuds og aflastningsfjeder, F	150,-
	25SB KK08 MPX	6 x 8 mm klemstuds og aflastningsfjeder, M	132,-
	25SB KK08 MPN	6 x 8 mm klemstuds og aflastningsfjeder, F	150,-
	25SB KK10 MPX	8 x 10 mm klemstuds og aflastningsfjeder, M	138,-
	25SB KK10 MPN	8 x 10 mm klemstuds og aflastningsfjeder, F	156,-
	25SB KK12 MPX	9 x 12 mm klemstuds og aflastningsfjeder, M	138,-
	25SB KK12 MPN	9 x 12 mm klemstuds og aflastningsfjeder, F	156,-



Best. nr.	Artikelnummer	Tilslutning	Kr/stk
	25SB AW10 MPX	1/8" udvendig gevind, Messing	75,-
	25SB AW10 MPN	1/8" udvendig gevind, Forniklet	93,-
025312SB	25SB AW13 MPX	1/4" udvendig gevind, Messing	75,-
025312SBN	25SB AW13 MPN	1/4" udvendig gevind, Forniklet	93,-
025314SB	25SB AW17 MPX	3/8" udvendig gevind, Messing	78,-
025314SBN	25SB AW17 MPN	3/8" udvendig gevind, Forniklet	98,-
025315SB	25SB AW21 MPX	1/2" udvendig gevind, Messing	79,-
025315SBN	25SB AW21 MPN	1/2" udvendig gevind, Forniklet	98,-



Best. nr.	Artikelnummer	Tilslutning	Kr/stk
025302SB	25SB IW13 MPX	1/4" indvendig gevind, Messing	93,-
025302SBN	25SB IW13 MPN	1/4" indvendig gevind, Forniklet	93,-
025304SB	25SB IW13 MPX	3/8" indvendig gevind, Messing	78,-
025304SBN	25SB IW13 MPN	3/8" indvendig gevind, Forniklet	98,-
025305SB	25SB IW13 MPX	1/2" indvendig gevind, Messing	79,-
025305SBN	25SB IW13 MPN	1/2" indvendig gevind, Forniklet	98,-



Best. nr.	Artikelnummer	Tilslutning	Kr/stk
027012KB	27KB AK13 BPX	1/4" udvendig gevind, Messing	412,-
027012KBN	27KB AK13 BPN	1/4" udvendig gevind, Forniklet	444,-
027014KB	27KB AK17 BPX	3/8" udvendig gevind, Messing	412,-
027014KBN	27KB AK17 BPN	3/8" udvendig gevind, Forniklet	444,-
027015KB	27KB AK21 BPX	1/2" udvendig gevind, Messing	412,-
027015KBN	27KB AK21 BPN	1/2" udvendig gevind, Forniklet	444,-
027017KB	27KB AK26 BPX	3/4" udvendig gevind, Messing	426,-
027017KBN	27KB AK26 BPN	3/4" udvendig gevind, Forniklet	461,-



Best. nr.	Artikelnummer	Tilslutning	Kr/stk
027002KB	27KB IW13 BPX	1/4" indvendig gevind, Messing	424,-
027002KBN	27KB IW13 BPN	1/4" indvendig gevind, Forniklet	444,-
027004KB	27KB IW17 BPX	3/8" indvendig gevind, Messing	424,-
027004KBN	27KB IW17 BPN	3/8" indvendig gevind, Forniklet	444,-
027005KB	27KB IW21 BPX	1/2" indvendig gevind, Messing	424,-
027005KBN	27KB IW21 BPN	1/2" indvendig gevind, Forniklet	444,-
027007KB	27KB IW26 BPX	3/4" indvendig gevind, Messing	424,-
027007KBN	27KB IW26 BPN	3/4" indvendig gevind, Forniklet	444,-



Best. nr.	Artikelnummer	Tilslutning	Kr/stk
027106KB	27KB TF06 BPX	6 mm slangestuds, Messing	443,-
027106KBN	27KB TF06 BPN	6 mm slangestuds, Forniklet	478,-
027108KB	27KB TF08 BPX	8 mm slangestuds, Messing	412,-
027108KBN	27KB TF08 BPN	8 mm slangestuds, Forniklet	445,-
027109KB	27KB TF09 BPX	9 mm slangestuds, Messing	412,-
027109KBN	27KB TF09 BPN	9 mm slangestuds, Forniklet	445,-
027110KB	27KB TF10 BPX	10 mm slangestuds, Messing	412,-
027110KBN	27KB TF10 BPN	10 mm slangestuds, Forniklet	447,-
027113KB	27KB TF13 BPX	13 mm slangestuds, Messing	412,-
027113KBN	27KB TF13 BPN	13 mm slangestuds, Forniklet	426,-
027116KB	27KB TF16 BPX	16 mm slangestuds, Messing	413,-
027116KBN	27KB TF16 BPN	16 mm slangestuds, Forniklet	447,-
027119KB	27KB TF19 BPX	19 mm slangestuds, Messing	416,-
027119KBN	27KB TF19 BPN	19 mm slangestuds, Forniklet	453,-



Best. nr.	Artikelnummer	Tilslutning	Kr/stk
027206SB	27SB TF06 MPX	6 mm slangestuds, Messing	298,-
027206SBN	27SB TF06 MPN	6 mm slangestuds, Forniklet	331,-
027208SB	27SB TF08 MPX	8 mm slangestuds, Messing	307,-
027208SBN	27SB TF08 MPN	8 mm slangestuds, Forniklet	339,-
027209SB	27SB TF09 MPX	9 mm slangestuds, Messing	307,-
027209SBN	27SB TF09 MPN	9 mm slangestuds, Forniklet	339,-
027210SB	27SB TF10 MPX	10 mm slangestuds, Messing	307,-
027210SBN	27SB TF10 MPN	10 mm slangestuds, Forniklet	339,-
027213SB	27SB TF13 MPX	13 mm slangestuds, Messing	307,-
027213SBN	27SB TF13 MPN	13 mm slangestuds, Forniklet	339,-
027216SB	27SB TF16 MPX	16 mm slangestuds, Messing	309,-
027216SBN	27SB TF16 MPN	16 mm slangestuds, Forniklet	342,-
027219SB	27SB TF19 MPX	19 mm slangestuds, Messing	292,-
027219SBN	27SB TF19 MPN	19 mm slangestuds, Forniklet	325,-



Best. nr.	Artikelnummer	Tilslutning	Kr/stk
027312SB	27SB AK13 MPX	1/4" udvendig gevind, Messing	276,-
027312SBN	27SB AK13 MPN	1/4" udvendig gevind, Forniklet	307,-
027314SB	27SB AK17 MPX	3/8" udvendig gevind, Messing	261,-
027314SBN	27SB AK17 MPN	3/8" udvendig gevind, Forniklet	294,-
027315SB	27SB AK21 MPX	1/2" udvendig gevind, Messing	261,-
027315SBN	27SB AK21 MPN	1/2" udvendig gevind, Forniklet	294,-
027317SB	27SB AK26 MPX	3/4" udvendig gevind, Messing	269,-
027317SBN	27SB AK26 MPN	3/4" udvendig gevind, Forniklet	302,-



Best. nr.	Artikelnummer	Tilslutning	Kr/stk
027302SB	27SB IW13 MPX	1/4" indvendig gevind, Messing	261,-
027302SBN	27SB IW13 MPN	1/4" indvendig gevind, Forniklet	294,-
027304SB	27SB IW17 MPX	3/8" indvendig gevind, Messing	261,-
027304SBN	27SB IW17 MPN	3/8" indvendig gevind, Forniklet	294,-
027305SB	27SB IW21 MPX	1/2" indvendig gevind, Messing	261,-
027305SBN	27SB IW21 MPN	1/2" indvendig gevind, Forniklet	294,-
027307SB	27SB IW26 MPX	3/4" indvendig gevind, Messing	280,-
027307SBN	27SB IW26 MPN	3/4" indvendig gevind, Forniklet	312,-



Stort udvalg af lynkoblinger og nipler i **POM** eller **CHEM**.
Kan fås med eller uden farvekode.

SERIE 71-76KB - ISO 7241-1 serie B profil med ventil i både kobling og nippel delen.

Specielt velegnet til brug med væsker. Stærk og holdbar kobling til stort tryk.

Kan leveres i messing eller rustfri udførelse AISI 303 eller 316 L. Vandflow fra 12-250 ltr/min.



Best. nr.	Artikelnummer	Tilslutning	Kr/stk
071000	71KB IW10 MPX	1/8" indvendig gevind, Messing	179,-
071000-303	71KB IW10 RVX	1/8" indvendig gevind, Rustfri Aisi 303	477,-
071000-316	71KB IW10 EVX	1/8" indvendig gevind, Rustfri Aisi 316	807,-



Best. nr.	Artikelnummer	Tilslutning	Kr/stk
071300	71SB IW10 MPX	1/8" indvendig gevind, Messing	101,-
071300-303	71SB IW10 RVX	1/8" indvendig gevind, Rustfri Aisi 303	181,-
071300-316	71SB IW10 EVX	1/8" indvendig gevind, Rustfri Aisi 316	384,-



Best. nr.	Artikelnummer	Tilslutning	Kr/stk
072002	72KB IW13 MPX	1/4" indvendig gevind, Messing	221,-
072002-303	72KB IW13 RVX	1/4" indvendig gevind, Rustfri Aisi 303	499,-
072002-316	72KB IW13 EVX	1/4" indvendig gevind, Rustfri Aisi 316	843,-



Best. nr.	Artikelnummer	Tilslutning	Kr/stk
072302	72SB IW13 MPX	1/4" indvendig gevind, Messing	138,-
072302-303	72SB IW13 RVX	1/4" indvendig gevind, Rustfri Aisi 303	198,-
072302-316	72SB IW13 EVX	1/4" indvendig gevind, Rustfri Aisi 316	422,-



Best. nr.	Artikelnummer	Tilslutning	Kr/stk
073004	73KB IW17 MPX	3/8" indvendig gevind, Messing	294,-
073004-303	73KB IW17 RVX	3/8" indvendig gevind, Rustfri Aisi 303	740,-
073004-316	73KB IW17 EVX	3/8" indvendig gevind, Rustfri Aisi 316	1.247,-



Best. nr.	Artikelnummer	Tilslutning	Kr/stk
073304	73SB IW17 MPX	3/8" indvendig gevind, Messing	175,-
073304-303	73SB IW17 RVX	3/8" indvendig gevind, Rustfri Aisi 303	301,-
073304-316	73SB IW17 EVX	3/8" indvendig gevind, Rustfri Aisi 316	489,-



Best. nr.	Artikelnummer	Tilslutning	Kr/stk
074005	74KB IW21 MPX	1/2" indvendig gevind, Messing	410,-
074005-303	74KB IW21 RVX	1/2" indvendig gevind, Rustfri Aisi 303	1.002,-
074005-316	74KB IW21 EVX	1/2" indvendig gevind, Rustfri Aisi 316	1.742,-



Best. nr.	Artikelnummer	Tilslutning	Kr/stk
074305	74SB IW21 MPX	1/2" indvendig gevind, Messing	225,-
074305-303	74SB IW21 RVX	1/2" indvendig gevind, Rustfri Aisi 303	489,-
074305-316	74SB IW21 EVX	1/2" indvendig gevind, Rustfri Aisi 316	617,-



Best. nr.	Artikelnummer	Tilslutning	Kr/stk
075007	75KB IW26 MPX	3/4" indvendig gevind, Messing	735,-
075007-303	75KB IW26 RVX	3/4" indvendig gevind, Rustfri Aisi 303	2.088,-
075007-316	75KB IW26 EVX	3/4" indvendig gevind, Rustfri Aisi 316	2.511,-

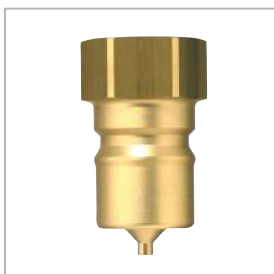

Best. nr.	Artikelnummer	Tilslutning	Kr/stk
075307	75SB IW26 MPX	3/4" indvendig gevind, Messing	357,-
075307-303	75SB IW26 RVX	3/4" indvendig gevind, Rustfri Aisi 303	887,-
075307-316	75SB IW26 EVX	3/4" indvendig gevind, Rustfri Aisi 316	1.052,-



Best. nr.	Artikelnummer	Tilslutning	Kr/stk
076009	76KB IW33 MPX	1" indvendig gevind, Messing	1.617,-
076009-303	76KB IW33 RVX	1" indvendig gevind, Rustfri Aisi 303	3.258,-
076009-316	76KB IW33 EVX	1" indvendig gevind, Rustfri Aisi 316	3.694,-



Best. nr.	Artikelnummer	Tilslutning	Kr/stk
076309	76SB IW33 MPX	1" indvendig gevind, Messing	1.016,-
076309-303	76SB IW33 RVX	1" indvendig gevind, Rustfri Aisi 303	2.042,-
076309-316	76SB IW33 EVX	1" indvendig gevind, Rustfri Aisi 316	2.218,-

SERIE 21KS - Sikkerhedskobling, 2 håndbetjent som forhindrer utilsigtet frakobling.

Lille kobling med høj luftgennemstrømning. Flow 500 ltr/min.



Best. nr.	Artikelnummer	Tilslutning	Kr/stk
021010KS	21KS AW10 MPX	1/8" udvendig gevind, Messing	87,-
021010KSN	21KS AW10 MPN	1/8" udvendig gevind, Forniklet	113,-
021012KS	21KS AW13 MPX	1/4" udvendig gevind, Messing	87,-
021012KSN	21KS AW13 MPN	1/4" udvendig gevind, Forniklet	113,-
021014KS	21KS AW17 MPX	3/8" udvendig gevind, Messing	95,-
021014KSN	21KS AW17 MPN	3/8" udvendig gevind, Forniklet	119,-



Best. nr.	Artikelnummer	Tilslutning	Kr/stk
021000KS	21KS IW10 MPX	1/8" indvendig gevind, Messing	87,-
021000KSN	21KS IW10 MPN	1/8" indvendig gevind, Forniklet	113,-
021002KS	21KS IW13 MPX	1/4" indvendig gevind, Messing	87,-
021002KSN	21KS IW13 MPN	1/4" indvendig gevind, Forniklet	113,-
021004KS	21KS IW17 MPX	3/8" indvendig gevind, Messing	95,-
021004KSN	21KS IW17 MPN	3/8" indvendig gevind, Forniklet	119,-



Best. nr.	Artikelnummer	Tilslutning	Kr/stk
021105KS	21KS TF05 MPX	5 mm slangestuds, Messing	97,-
021105KSN	21KS TF05 MPN	5 mm slangestuds, Forniklet	122,-
021106KS	21KS TF06 MPX	6 mm slangestuds, Messing	95,-
021106KSN	21KS TF06 MPN	6 mm slangestuds, Forniklet	122,-
021108KS	21KS TF08 MPX	8 mm slangestuds, Messing	100,-
021108KSN	21KS TF08 MPN	8 mm slangestuds, Forniklet	126,-
021109KS	21KS TF09 MPX	9 mm slangestuds, Messing	100,-
021109KSN	21KS TF09 MPN	9 mm slangestuds, Forniklet	126,-
021110KS	21KS TF10 MPX	10 mm slangestuds, Messing	101,-
021110KSN	21KS TF10 MPN	10 mm slangestuds, Forniklet	126,-



Best. nr.	Artikelnummer	Tilslutning	Kr/stk
021310SS	21SS AW10 MXX	1/8" udvendig gevind, Messing	43,-
021310SSN	21SS AW10 MXN	1/8" udvendig gevind, Forniklet	48,-
021312SS	21SS AW13 MXX	1/4" udvendig gevind, Messing	39,-
021312SSN	21SS AW13 MXN	1/4" udvendig gevind, Forniklet	48,-



Best. nr.	Artikelnummer	Tilslutning	Kr/stk
021300SS	21SS IW10 MXX	1/8" indvendig gevind, Messing	44,-
021300SSN	21SS IW10 MXN	1/8" indvendig gevind, Forniklet	48,-
021302SS	21SS IW13 MXX	1/4" indvendig gevind, Messing	39,-
021302SSN	21SS IW13 MXN	1/4" indvendig gevind, Forniklet	48,-



Best. nr.	Artikelnummer	Tilslutning	Kr/stk
021206SS	21SS TF06 MXX	6 mm slangestuds, Messing	30,-
021206SSN	21SS TF06 MXN	6 mm slangestuds, Forniklet	42,-
021208SS	21SS TF08 MXX	8 mm slangestuds, Messing	32,-
021208SSN	21SS TF08 MXN	8 mm slangestuds, Forniklet	44,-
021209SS	21SS TF09 MXX	9 mm slangestuds, Messing	32,-
021209SSN	21SS TF09 MXN	9 mm slangestuds, Forniklet	44,-
021210SS	21SS TF10 MXX	10 mm slangestuds, Messing	32,-
021210SSN	21SS TF10 MXN	10 mm slangestuds, Forniklet	44,-

SERIE 21KD - Sikkerhedskobling, 2 håndsbetjent som forhindrer utilsigtet frakobling.

Med ventil i både kobling og nippel delen. Forniklet udførelse. Flow 175 ltr/min.



Best. nr.	Artikelnummer	Tilslutning	Kr/stk
021010KDN	21KD AW10 MPN	1/8" udvendig gevind	141,-
021012KDN	21KD IW13 MPN	1/4" udvendig gevind	141,-
021014KDN	21KD AW17 MPN	3/8" udvendig gevind	149,-



Best. nr.	Artikelnummer	Tilslutning	Kr/stk
021000KDN	21KD IW10 MPN	1/8" indvendig gevind	141,-
021002KDN	21KD IW13 MPN	1/4" indvendig gevind	141,-
021004KDN	21KD IW17 MPN	3/8" indvendig gevind	149,-



Best. nr.	Artikelnummer	Tilslutning	Kr/stk
021106KDN	21KD TF06 MPN	6 mm slangestuds	148,-
021108KDN	21KD TF08 MPN	8 mm slangestuds	151,-
021110KDN	21KD TF10 MPN	10 mm slangestuds	156,-



Best. nr.	Artikelnummer	Tilslutning	Kr/stk
021310SDN	21SD AW10 MPN	1/8" udvendig gevind	111,-
021312SDN	21SD AW13 MPN	1/4" udvendig gevind	111,-
021314SDN	21SD AW17 MPN	3/8" udvendig gevind	134,-



Best. nr.	Artikelnummer	Tilslutning	Kr/stk
021300SDN	21SD IW10 MPN	1/8" indvendig gevind	111,-
021302SDN	21SD IW13 MPN	1/4" indvendig gevind	111,-
021304SDN	21SD IW17 MPN	3/8" indvendig gevind	134,-



Best. nr.	Artikelnummer	Tilslutning	Kr/stk
021206SDN	21SD TF06 MPN	6 mm slangestuds	126,-
021208SDN	21SD TF08 MPN	8 mm slangestuds	129,-
021210SDN	21SD TF10 MPN	10 mm slangestuds	130,-

SERIE 95KS - Sikkerhedskobling, 2 håndsbetjent som forhindrer utilsigtet frakobling.

Testet iht. EN 139 standard. Forniklet udførelse. Flow 1700 ltr/min.



Best. nr.	Artikelnummer	Tilslutning	Kr/stk
095012KS	95KS AK13 BPN	1/4" udvendig gevind	368,-
095014KS	95KS AK17 BPN	3/8" udvendig gevind	342,-
095015KS	95KS AK21 BPN	1/2" udvendig gevind	383,-



Best. nr.	Artikelnummer	Tilslutning	Kr/stk
095002KS	95KS IW13 BPN	1/4" indvendig gevind	368,-
095004KS	95KS IW17 BPN	3/8" indvendig gevind	368,-
095005KS	95KS IW21 BPN	1/2" indvendig gevind	383,-



Best. nr.	Artikelnummer	Tilslutning	Kr/stk
095106KS	95KS TF06 BPN	6 mm slangestuds	368,-
095107KS	95KS TF07 BPN	7 mm slangestuds	380,-
095108KS	95KS TF08 BPN	8 mm slangestuds	380,-
095109KS	95KS TF09 BPN	9 mm slangestuds	368,-
095110KS	95KS TF10 BPN	10 mm slangestuds	368,-
095113KS	95KS TF13 BPN	13 mm slangestuds	383,-



Best. nr.	Artikelnummer	Tilslutning	Kr/stk
095312SS	95SS AK13 MXN	1/4" udvendig gevind	54,-
095314SS	95SS AK17 MXN	3/8" udvendig gevind	54,-



Best. nr.	Artikelnummer	Tilslutning	Kr/stk
095302SS	95SS IW13 MXN	1/4" indvendig gevind	54,-
095304SS	95SS IW17 MXN	3/8" indvendig gevind	54,-



Best. nr.	Artikelnummer	Tilslutning	Kr/stk
095206SS	95SS TF06 MXN	6 mm slangestuds	83,-
095209SS	95SS TF09 MXN	9 mm slangestuds	83,-
095210SS	95SS TF10 MXN	10 mm slangestuds	87,-

SERIE 96KS - Sikkerhedskobling, 2 håndsbetjent som forhindrer utilsigtet frakobling.

Testet iht. EN 139 standard. Forniklet udførelse. Flow 1700 ltr/min.



Best. nr.	Artikelnummer	Tilslutning	Kr/stk
096012KS	96KS AK13 BPN	1/4" udvendig gevind	391,-
096014KS	96KS AK17 BPN	3/8" udvendig gevind	391,-
096015KS	96KS AK21 BPN	1/2" udvendig gevind	399,-



Best. nr.	Artikelnummer	Tilslutning	Kr/stk
096002KS	96KS IW13 BPN	1/4" indvendig gevind	391,-
096004KS	96KS IW17 BPN	3/8" indvendig gevind	391,-
096005KS	96KS IW21 BPN	1/2" indvendig gevind	403,-



Best. nr.	Artikelnummer	Tilslutning	Kr/stk
096106KS	96KS TF06 BPN	6 mm slangestuds	391,-
096107KS	96KS TF07 BPN	7 mm slangestuds	425,-
096109KS	96KS TF09 BPN	9 mm slangestuds	391,-
096110KS	96KS TF10 BPN	10 mm slangestuds	391,-
096113KS	96KS TF13 BPN	13 mm slangestuds	425,-



Best. nr.	Artikelnummer	Tilslutning	Kr/stk
096312SS	96SS AK13 MXN	1/4" udvendig gevind	59,-
096314SS	96SS AK17 MXN	3/8" udvendig gevind	59,-



Best. nr.	Artikelnummer	Tilslutning	Kr/stk
096302SS	96SS IW13 MXN	1/4" indvendig gevind	59,-
096304SS	96SS IW17 MXN	3/8" indvendig gevind	59,-



Best. nr.	Artikelnummer	Tilslutning	Kr/stk
096206SS	96SS TF06 MXN	6 mm slangestuds	44,-
096209SS	96SS TF09 MXN	9 mm slangestuds	44,-
096213SS	96SS TF13 MXN	13 mm slangestuds	48,-

SERIE 1600KE - EUROSTANDARD profil. Udluftende sikkerhedskobling med stort flow og ekstrem nem til- & frakobling. 2100 ltr/min.

SERIE 009 - EUROSTANDARD profil. Sikkerhedskobling med trykknop. 1 tryk, 1 teknologi, 1 serie. Ekstrem nem og sikker til- & fra kobling blot ved ét tryk.

Automatik udluftning ved frakobling. Heavy-duty komposit materiale, antistatisk, ultra lav vægt og stort flow (2100 l/min).



Best. nr.	Artikelnummer	Tilslutning	Kr/stk
01600012KE	1600KE AK13 SPN	1/4" udvendig gevind	322,-
01600014KE	1600KE AK17 SPN	3/8" udvendig gevind	322,-
01600015KE	1600KE AK21 SPN	1/2" udvendig gevind	329,-



Best. nr.	Artikelnummer	Tilslutning	Kr/stk
01600002KE	1600KE IW13 SPN	1/4" indvendig gevind	322,-
01600004KE	1600KE IW17 SPN	3/8" indvendig gevind	322,-
01600005KE	1600KE IW21 SPN	1/2" indvendig gevind	329,-



Best. nr.	Artikelnummer	Tilslutning	Kr/stk
01600106KE	1600KE TF06 SPN	6 mm slangestuds	322,-
01600108KE	1600KE TF07 SPN	7 mm slangestuds	322,-
01600109KE	1600KE TF09 SPN	9 mm slangestuds	322,-
01600110KE	1600KE TF10 SPN	10 mm slangestuds	322,-
01600113KE	1600KE TF13 SPN	13 mm slangestuds	329,-



Best. nr.	Artikelnummer	Tilslutning	Kr/stk
009002	ESI 071101	1/4" indvendig gevind	177,-
009004	ESI 071102	3/8" indvendig gevind	182,-
009005	ESI 071103	1/2" indvendig gevind	186,-



Best. nr.	Artikelnummer	Tilslutning	Kr/stk
009012	ESI 071151	1/4" udvendig gevind	177,-
009014	ESI 071152	3/8" udvendig gevind	182,-
009015	ESI 071153	1/2" udvendig gevind	186,-



Best. nr.	Artikelnummer	Tilslutning	Kr/stk
009106	ESI 071806	6 mm slangestuds	186,-
009108	ESI 071808	8 mm slangestuds	186,-
009109	ESI 071809	9 mm slangestuds	186,-
009110	ESI 071810	10 mm slangestuds	186,-
009113	ESI 071813	13 mm slangestuds	186,-



Best. nr.	Artikelnr.	Beskrivelse	Kr/stk
O53506	53506A3	NITO 1/2" Koblingsæt med 1/2" koblingshus og koblingsnippel med 1/2" slangespids	99,-

Pakket på blister/SB kort

Best nr.	Kr/stk
B53506	103,-



Best. nr.	Artikelnr.	Beskrivelse	Kr/stk
O53500	53500A3	NITO 1/2" Koblingshus med 1/2" indvendig gevind RG	74,-
O53520	53520A3	NITO 1/2" Koblingshus med 3/4" indvendig gevind RG	80,-
O5352G	5352GA3	NITO 1/2" Koblingshus med 1/2", 3/4" RG og M22x1 indvendig gevind	109,-

Pakket på blister/SB kort

Best nr.	Kr/stk
B53500	78,-
B53520	84,-
B5352G	113,-



Best. nr.	Artikelnr.	Beskrivelse	Kr/stk
O53530	53530A3	NITO 1/2" Koblingshus med stop og indvendig 3/4" RG	147,-

Pakket på blister/SB kort

Best nr.	Kr/stk
B53530	151,-



Best. nr.	Artikelnr.	Beskrivelse	Kr/stk
O5350N	5350NA3	NITO 1/2" Koblingshus med 1/2" udvendig RG	83,-
O5352N	5352NA3	NITO 1/2" Koblingshus med 3/4" udvendig RG	82,-

Pakket på blister/SB kort

Best nr.	Kr/stk
B5350N	87,-
B5352N	86,-



Best. nr.	Artikelnr.	Beskrivelse	Kr/stk
O5353N	5353NA3	NITO 1/2" Koblingshus med stop og 1/2" udvendig RG	162,-

Pakket på blister/SB kort

Best nr.	Kr/stk
B5353N	166,-



Best. nr.	Artikelnr.	Beskrivelse	Kr/stk
O5350S	5350SA3	NITO 1/2" Koblingshus med 1/2" slangespids	87,-
O5351S	5351SA3	NITO 1/2" Koblingshus med 3/4" slangespids	83,-

Pakket på blister/SB kort

Best nr.	Kr/stk
B5350S	91,-
B5351S	87,-



Best. nr.	Artikelnr.	Beskrivelse	Kr/stk
O5353S	5353SA3	NITO 1/2" Koblingshus med stop og 1/2" Slangespids	140,-
O5354S	5354SA3	NITO 1/2" Koblingshus med stop og 3/4" Slangespids	179,-

Pakket på blister/SB kort

Best nr.	Kr/stk
B5353S	144,-
B5354S	183,-



Best. nr.	Artikelnr.	Beskrivelse	Kr/stk
O53600	53600A3	NITO 1/2" Koblingsnippel med 1/2" slangespids	30,-
O5360E	5360EA3	NITO 1/2" Koblingsnippel med 3/4" slangespids	36,-
O5360B	5360BA3	NITO 1/2" Koblingsnippel med 3/8" slangespids	34,-
O5360C	5360CA3	NITO 1/2" Koblingsnippel med 5/8" slangespids	33,-
O5360D	5360DA3	NITO 1/2" Koblingsnippel med 1/4" slangespids	34,-

Pakket på blister/SB kort

Best nr.	Kr/stk
B53600	34,-
B5360E	40,-
B5360B	38,-
B5360C	37,-
B5360D	38,-



Best. nr.	Artikelnr.	Beskrivelse	Kr/stk
O53650	53650A3	NITO 1/2" Koblingsled monteret mellem 2 Slangekoblinger	64,-

Pakket på blister/SB kort

Best nr.	Kr/stk
B53650	68,-



Best. nr.	Artikelnr.	Beskrivelse	Kr/stk
O5360A	5360AA3	NITO 1/2" Koblingsnippel med dobbelt slangespids til 3/4" og 1/2" slange	42,-

Pakket på blister/SB kort

Best nr.	Kr/stk
B5360A	46,-



Best. nr.	Artikelnr.	Beskrivelse	Kr/stk
O53610	53610A3	NITO 1/2" Koblingsnippel med 1/2" indvendig RG	38,-
O5361A	5361AA3	NITO 1/2" Koblingsnippel med 3/4" indvendig RG	41,-

Pakket på blister/SB kort

Best nr.	Kr/stk
B53610	42,-
B5361A	45,-



Best. nr.	Artikelnr.	Beskrivelse	Kr/stk
O53640	53640A3	NITO 1/2" Koblingsnippel med 1/2" udvendig RG	33,-
O5364A	5364AA3	NITO 1/2" Koblingsnippel med 3/4" udvendig RG	40,-

Pakket på blister/SB kort

Best nr.	Kr/stk
B53640	37,-
B5364A	44,-



Best. nr.	Artikelnr.	Beskrivelse	Kr/stk
O5361X	5361XA3	NITO 1/2" Selvkærende koblingsnippel	29,-

Pakket på blister/SB kort

Best nr.	Kr/stk
B5361X	33,-



Best. nr.	Artikelnr.	Beskrivelse	Kr/stk
O53670	53670A3	NITO 1/2" Slangør med 1/2" udvendig RG og 1/2" slangespids	29,-

Pakket på blister/SB kort

Best nr.	Kr/stk
B53670	33,-



Best. nr.	Artikelnr.	Beskrivelse	Kr/stk
O53750	53750A3	NITO 1/2" Indstilleligt Strålerør til 1/2" Slangkobling	136,-

Pakket på blister/SB kort

Best nr.	Kr/stk
B53750	140,-



Best. nr.	Artikelnr.	Beskrivelse	Kr/stk
O53760	53760A3	NITO Fordelerled med 1/2" koblingsnipler	174,-

Pakket på blister/SB kort

Best nr.	Kr/stk
B53760	178,-



claber

SE CLABER I SEPERAT KATALOG



Best. nr.	Artikelnr.	Beskrivelse	Kr/stk
O63506	63506A3	NITO 3/4" Koblings sæt med 3/4" Koblingshus og koblingsnippel med 3/4" Slangespids	119,-

Pakket på blister/SB kort

Best nr.	Kr/stk
B63506	123,-



Best. nr.	Artikelnr.	Beskrivelse	Kr/stk
O63500	63500A3	NITO 3/4" Koblingshus med 3/4" indvendig RG	82,-

Pakket på blister/SB kort

Best nr.	Kr/stk
B63500	86,-



Best. nr.	Artikelnr.	Beskrivelse	Kr/stk
O63530	63530A3	NITO 3/4" Koblingshus med stop og 3/4" indvendig RG	269,-

Pakket på blister/SB kort

Best nr.	Kr/stk
B63530	273,-



Best. nr.	Artikelnr.	Beskrivelse	Kr/stk
O63505	63505A3	NITO 3/4" Koblingshus med 3/4" Slangespids	110,-

Pakket på blister/SB kort

Best nr.	Kr/stk
B63505	114,-



Best. nr.	Artikelnr.	Beskrivelse	Kr/stk
O63535	63535A3	NITO 3/4" Koblingshus med stop og 3/4" Slangespids	285,-

Pakket på blister/SB kort

Best nr.	Kr/stk
B63535	289,-



Best. nr.	Artikelnr.	Beskrivelse	Kr/stk
O63600	63600A3	NITO 3/4" Koblingsnippel med 3/4" slangespids	49,-
O6360B	6360BA3	NITO 3/4" Koblingsnippel med 1/2" slangespids	41,-

Pakket på blister/SB kort

Best nr.	Kr/stk
B63600	53,-
B6360B	45,-



Best. nr.	Artikelnr.	Beskrivelse	Kr/stk
O6360A	6360AA3	NITO 3/4" Koblingsnippel med dobbelt slangespids til 1" og 3/4" Slange	81,-

Pakket på blister/SB kort

Best nr.	Kr/stk
B6360A	85,-



Best. nr.	Artikelnr.	Beskrivelse	Kr/stk
O63610	63610A3	NITO 3/4" Koblingsnippel med 3/4" indvendig RG	55,-
O6361A	6361AA3	NITO 3/4" Koblingsnippel med 1/2" indvendig RG	40,-

Pakket på blister/SB kort

Best nr.	Kr/stk
B63610	59,-
B6361A	44,-



Best. nr.	Artikelnr.	Beskrivelse	Kr/stk
O63640	63640A3	NITO 3/4" Koblingsnippel med 3/4" udvendig RG	43,-
O6364A	6364AA3	NITO 3/4" Koblingsnippel med 1/2" udvendig RG	46,-

Pakket på blister/SB kort

Best nr.	Kr/stk
B63640	47,-
B6364A	50,-



Best. nr.	Artikelnr.	Beskrivelse	Kr/stk
O63670	63670A3	NITO 3/4" Slangerør m. 3/4" udvendig RG og 3/4" slangespids	40,-

Pakket på blister/SB kort

Best nr.	Kr/stk
B63670	44,-



Best. nr.	Artikelnr.	Beskrivelse	Kr/stk
O63750	63750A3	NITO 3/4" Strålerør til 3/4" slangekobling	146,-

Pakket på blister/SB kort

Best nr.	Kr/stk
B63750	150,-



Best. nr.	Artikelnr.	Beskrivelse	Kr/stk
O53690	53690A3	NITO Overgangsstykke med 1/2" udvendig RG og 3/4" indvendig RG	29,-

Pakket på blister/SB kort

Best nr.	Kr/stk
B53690	33,-



Best. nr.	Artikelnr.	Beskrivelse	Kr/stk
O5369B	5369BA3	NITO Overgangsstykke med M22x1 udvendig RG og 1/2" indvendig RG	25,-

Pakket på blister/SB kort

Best nr.	Kr/stk
B5369B	29,-



Best. nr.	Artikelnr.	Beskrivelse	Kr/stk
O53700	53700A3	NITO Overgangsstykke med 1/2" udvendig RG og M22x1 indvendig RG	28,-

Pakket på blister/SB kort

Best nr.	Kr/stk
B53700	32,-



Best. nr.	Artikelnr.	Beskrivelse	Kr/stk
O53740	53740A3	NITO Overgangsstykke med M22x1 udvendig RG og M24x1 udvendig RG	28,-

Pakket på blister/SB kort

Best nr.	Kr/stk
B53740	32,-



Best. nr.	Artikelnr.	Beskrivelse	Kr/stk
O63690	63690A3	NITO Overgangsstykke med 3/4" udvendig RG og 1" indvendig RG	51,-

Pakket på blister/SB kort

Best nr.	Kr/stk
B63690	55,-



Best. nr.	Artikelnr.	Beskrivelse	Kr/stk
O53480	53480A8	Gevindring med udvendig 3/4" og indvendig 1/2" RG / M22x1 gevind	25,-
O53490	53490A8	Gevindring med udvendig 3/4" og indvendig 1/2" RG	27,-

Pakket på blister/SB kort

Best nr.	Kr/stk
B53480	29,-
B53490	31,-



Best. nr.	Artikelnr.	Beskrivelse	Kr/stk
O15020	15020A4	NITO Samlerør 14mm x 14mm / 1/2" samler	11,-
O15030	15030A4	NITO Samlerør 20mm x 20mm / 3/4" samler	17,-
O15040	15040A4	NITO Samlerør 25mm x 25mm / 1" samler	34,-

Pakket på blister/SB kort

Best nr.	Kr/stk
B15020	15,-
B15030	21,-
B15040	28,-



Best. nr.	Artikelnr.	Beskrivelse	Kr/stk
O27110	27110A4	NITO 1/2" slangespids med 1/2" udvendig	24,-
O27210	27210A4	NITO 3/4" slangespids med 3/4" udvendig	19,-
O27240	27240A4	NITO 3/4" slangespids med 1" udvendig	41,-
O27410	27410A4	NITO 1" slangespids med 1" udvendig	42,-
O27710	27710A4	NITO 1 1/4" slangespids med 1 1/4" udvendig	167,-
O27790	27790A4	NITO 1/2" slangespids med 3/4" udvendig	19,-
O27810	27810A4	NITO 1 1/2" slangespids med 1 1/2" udvendig	178,-
O27910	27910A4	NITO 2" slangespids med 2" udvendig	209,-

Pakket på blister/SB kort

Best nr.	Kr/stk
B27110	28,-
B27210	23,-
B27240	45,-
B27410	46,-
B27710	171,-
B27790	23,-
B27810	182,-
B27910	213,-



Best. nr.	Artikelnr.	Beskrivelse	Kr/stk
O27150	27150A4	NITO 1/2" Omløber x 1/2" slangespids	20,-
O27250	27250A4	NITO 3/4" Omløber x 3/4" slangespids	26,-
O27350	27350A4	NITO 3/4" Omløber x 1/2" slangespids	24,-

Pakket på blister/SB kort

Best nr.	Kr/stk
B27150	24,-
B27250	30,-
B27350	28,-



Best. nr.	Artikelnr.	Beskrivelse	Kr/stk
O27160	27160A4	NITO Slangeforskruning dobbelt for 1/2" Slangespids, 15mm x 15mm	24,-
O27260	27260A4	NITO Slangeforskruning dobbelt 3/4" Slangespids, 20mm x 20mm	55,-
O27360	27360A4	NITO Slangeforskruning dobbelt 1/2" x 3/4" Slangespids, 15mm x 20mm	56,-

Pakket på blister/SB kort

Best nr.	Kr/stk
B27160	31,-
B27260	59,-
B27360	60,-



Best. nr.	Artikelnr.	Beskrivelse	Kr/stk
O27450	27450A4	NITO 1" Slangeforskruning med 1" Slangespids	66,-
O27550	27550A4	NITO 1/2" Slangeforskruning med 1" Slangespids	39,-
O27650	27650A4	NITO 3/4" Slangeforskruning med 1" Slangespids	46,-
O27750	27750A4	NITO 1 1/4" Slangeforskruning med 1 1/4" Slangespids	190,-
O27850	27850A4	NITO 1 1/2" Slangeforskruning med 1 1/2" Slangespids	190,-
O27950	27950A4	NITO 2" Slangeforskruning med 2" Slangespids	484,-

Pakket på blister/SB kort

Best nr.	Kr/stk
B27450	70,-
B27550	43,-
B27650	50,-
B27750	194,-
B27850	194,-
B27950	488,-



Best. nr.	Artikelnr.	Beskrivelse	Kr/stk
O53800	53800A1	NITO I Vandings- & spulepistol pistol med 1/2" koblingsnippel	302,-



Best. nr.	Artikelnr.	Beskrivelse	Kr/stk
O30000	30000A3	NITO Industripistol "Heavy Duty" - blå monteret m. 3/4" slangestuds	853,-
O30000A	30000A0	NITO Industripistol "Heavy Duty" - blå monteret m. 1/2" indv. gevind	853,-



Best. nr.	Artikelnr.	Beskrivelse	Kr/stk
O40525	40525	NITO Ergo industripistol monteret med 1/2" koblingsnippel	661,-
O40500	40500	NITO Ergo industripistol monteret med 3/4" koblingsnippel	661,-



Best. nr.	Artikelnr.	Beskrivelse	Kr/stk
O30550	30550	NITO II industripistol 3/4" indv. gevind	950,-



SE CLABER I SEPERAT KATALOG



Best. nr.	Tilslutning	Kr/stk
451503	Reduktionsventil, 15-3 bar, 1/4" gevind	91,-
451504	Reduktionsventil, 15-4 bar, 1/4" gevind	92,-
451505	Reduktionsventil, 15-5 bar, 1/4" gevind	98,-
451506	Reduktionsventil, 15-6 bar, 1/4" gevind	107,-
451508	Reduktionsventil, 15-8 bar, 1/4" gevind	126,-

FITTINGS FORNIKLET MESSING

SLANGESTUDS INDVENDIG GEVIND



Best. nr.	Tilslutning	Kr/stk
602202	6 mm slangestuds x 1/4" i.g.	18,-
602204	6 mm slangestuds x 3/8" i.g.	43,-
602205	6 mm slangestuds x 1/2" i.g.	49,-
602302	8 mm slangestuds x 1/4" i.g.	18,-
602304	8 mm slangestuds x 3/8" i.g.	42,-
602305	8 mm slangestuds x 1/2" i.g.	49,-
602402	9 mm slangestuds x 1/4" i.g.	18,-
602404	9 mm slangestuds x 3/8" i.g.	21,-
602405	9 mm slangestuds x 1/2" i.g.	49,-
602502	13 mm slangestuds x 1/4" i.g.	38,-
602504	13 mm slangestuds x 3/8" i.g.	20,-
602505	13 mm slangestuds x 1/2" i.g.	30,-

Pakket på blister/SB kort

Best. nr.	Kr/stk
B602202	22,-
B602204	47,-
B602205	54,-
B602302	22,-
B602304	46,-
B602305	54,-
B602402	22,-
B602404	25,-
B602405	54,-
B602502	42,-
B602504	24,-
B602505	35,-

SLANGESTUDS UDVENDIG GEVIND



Best. nr.	Tilslutning	Kr/stk
612110	5 mm slangestuds x 1/8" u.g.	8,-
612112	5 mm slangestuds x 1/4" u.g.	15,-
612210	6 mm slangestuds x 1/8" u.g.	7,-
612212	6 mm slangestuds x 1/4" u.g.	8,-
612214	6 mm slangestuds x 3/8" u.g.	25,-
612215	6 mm slangestuds x 1/2" u.g.	47,-
612310	8 mm slangestuds x 1/8" u.g.	8,-
612312	8 mm slangestuds x 1/4" u.g.	9,-
612314	8 mm slangestuds x 3/8" u.g.	16,-
612315	8 mm slangestuds x 1/2" u.g.	22,-
612410	9 mm slangestuds x 1/8" u.g.	8,-
612412	9 mm slangestuds x 1/4" u.g.	13,-
612414	9 mm slangestuds x 3/8" u.g.	16,-
612415	9 mm slangestuds x 1/2" u.g.	23,-
612417	9 mm slangestuds x 3/4" u.g.	49,-
612512	13 mm slangestuds x 1/4" u.g.	13,-
612514	13 mm slangestuds x 3/8" u.g.	17,-
612515	13 mm slangestuds x 1/2" u.g.	24,-
612517	13 mm slangestuds x 3/4" u.g.	49,-
612615	16 mm slangestuds x 1/2" u.g.	26,-
612617	16 mm slangestuds x 3/4" u.g.	47,-
612715	19 mm slangestuds x 1/2" u.g.	34,-
612717	19 mm slangestuds x 3/4" u.g.	53,-
612617	25 mm slangestuds x 3/4" u.g.	47,-
612919	25 mm slangestuds x 1" u.g.	103,-

Pakket på blister/SB kort

Best. nr.	Kr/stk
B612110	13,-
B612112	19,-
B612210	12,-
B612212	13,-
B612214	26,-
B612215	52,-
B612310	13,-
B612312	14,-
B612314	20,-
B612315	26,-
B612410	13,-
B612412	17,-
B612414	20,-
B612415	27,-
B612417	54,-
B612512	17,-
B612514	21,-
B612515	28,-

SLANGESTUDS MESSING



Best. nr.	Tilslutning	Kr/stk
M411006	6 mm x 1/8" u.g.	9,-
M411008	8 mm x 1/8" u.g.	19,-
M411009	9 mm x 1/8" u.g.	14,-
M411306	6 mm x 1/4" u.g.	15,-
M411308	8 mm x 1/4" u.g.	15,-
M411309	9 mm x 1/4" u.g.	15,-
M411706	6 mm x 3/8" u.g.	21,-
M411708	8 mm x 3/8" u.g.	23,-
M411709	9 mm x 3/8" u.g.	21,-
M411713	13 mm x 3/8" u.g.	20,-
M412106	6 mm x 1/2" u.g.	52,-
M412113	13 mm x 1/2" u.g.	27,-
M412119	19 mm x 1/2" u.g.	58,-
M412616	16 mm x 3/4" u.g.	65,-
M412619	19 mm x 3/4" u.g.	70,-
M412625	25 mm x 3/4" u.g.	62,-
M413319	19 mm x 1" u.g.	108,-

SLANGESAMLER



Best. nr.	Tilslutning	Kr/stk
M390404L	4 mm x 4 mm, lang	15,-
M390505	5 mm x 5 mm	17,-
M390606	6 mm x 6 mm	20,-
M390808	8 mm x 8 mm	21,-
M390909	9 mm x 9 mm	23,-
M391313	13 mm x 13 mm	30,-
M391616	16 mm x 16 mm	44,-
M392525	25 mm x 25 mm	54,-

Pakket på blister/SB kort

Best. nr.	Kr/stk
B390404L	19,-
B390505	21,-
B390606	24,-
B390808	25,-
B390909	27,-
B391313	35,-
B391616	48,-
B392525	58,-

SPIDSMUFFE



Best. nr.	Tilslutning	Kr/stk
621010	1/8" u.g. x 1/8" i.g.	8,-
621013	1/8" u.g. x 1/4" i.g.	13,-
621017	1/8" u.g. x 3/8" i.g.	19,-
621313	1/4" u.g. x 1/4" i.g.	14,-
621317	1/4" u.g. x 3/8" i.g.	20,-
621321	1/4" u.g. x 1/2" i.g.	26,-
621717	3/8" u.g. x 3/8" i.g.	20,-
621721	3/8" u.g. x 1/2" i.g.	25,-
622121	1/2" u.g. x 1/2" i.g.	40,-
622126	1/2" u.g. x 3/4" i.g.	53,-
631709	3/4" u.g. x 1" i.g.	75,-

Pakket på blister/SB kort

Best. nr.	Kr/stk
B621010	13,-
B631002	17,-
B621017	23,-
B631202	18,-
B631204	24,-
B621321	30,-
B631404	24,-
B631405	29,-

NIPPELMUFFE



Best. nr.	Tilslutning	Kr/stk
631200	1/4" u.g. x 1/8" i.g.	7,-
631400	3/8" u.g. x 1/8" i.g.	13,-
631402	3/8" u.g. x 1/4" i.g.	13,-
631500	1/2" u.g. x 1/8" i.g.	20,-
631502	1/2" u.g. x 1/4" i.g.	20,-
631504	1/2" u.g. x 3/8" i.g.	18,-
631704	3/4" u.g. x 3/8" i.g.	41,-
631705	3/4" u.g. x 1/2" i.g.	34,-
631907	1" u.g. x 3/4" i.g.	82,-

Pakket på blister/SB kort

Best. nr.	Kr/stk
B631200	12,-
B631400	17,-
B631402	17,-
B631500	24,-
B631502	24,-
B631504	22,-
B631704	45,-
B631705	38,-

BRYSTNIPPEL



Best nr.	Beskrivelse	Kr/stk
641010	1/8" u.g. x 1/8" u.g.	6,-
641012	1/8" u.g. x 1/4" u.g.	9,-
641014	1/8" u.g. x 3/8" u.g.	15,-
641212	1/4" u.g. x 1/4" u.g.	9,-
641214	1/4" u.g. x 3/8" u.g.	16,-
641215	1/4" u.g. x 1/2" u.g.	22,-
641414	3/8" u.g. x 3/8" u.g.	16,-
641415	3/8" u.g. x 1/2" u.g.	23,-
641515	1/2" u.g. x 1/2" u.g.	24,-
641517	1/2" u.g. x 3/4" u.g.	46,-
641717	3/4" u.g. x 3/4" u.g.	50,-
641719	3/4" u.g. x 1" u.g.	65,-
641919	1" u.g. x 1" u.g.	71,-

Pakket på blister/SB kort

Best nr.	Kr/stk
B641010	11,-
B641012	14,-
B641014	19,-
B641212	14,-
B641214	20,-
B641215	26,-
B641414	20,-
B641415	27,-
B641515	28,-

MUFFE



Best nr.	Beskrivelse	Kr/stk
650000	1/8" i.g. x 1/8" i.g.	7,-
650002	1/8" i.g. x 1/4" i.g.	15,-
650202	1/4" i.g. x 1/4" i.g.	14,-
650204	1/4" i.g. x 3/8" i.g.	20,-
650205	1/4" i.g. x 1/2" i.g.	24,-
650404	3/8" i.g. x 3/8" i.g.	20,-
650405	3/8" i.g. x 1/2" i.g.	25,-
650505	1/2" i.g. x 1/2" i.g.	34,-
650507	1/2" i.g. x 3/4" i.g.	50,-
650707	3/4" i.g. x 3/4" i.g.	49,-
650709	3/4" i.g. x 1" i.g.	135,-
650909	1" i.g. x 1" i.g.	170,-

Pakket på blister/SB kort

Best nr.	Kr/stk
B650000	12,-
B650002	19,-
B650202	18,-
B650204	24,-
B650205	28,-
B650404	24,-
B650405	28,-
B650505	38,-

PROP MED UNBRACO-HUL OG O-RING



Best nr.	Tilslutning	Kr/stk
651000	1/8"	6,-
651200	1/4"	8,-
651400	3/8"	13,-
651500	1/2"	19,-

Pakket på blister/SB kort

Best nr.	Kr/stk
B651000	11,-
B651200	13,-
B651400	17,-
B651500	23,-

PROP MED SEKSKANTET HOVED



Best nr.	Tilslutning	Kr/stk
651006	1/8"	6,-
651206	1/4"	8,-
651406	3/8"	11,-
651506	1/2"	18,-



Best nr.	Beskrivelse	Kr/stk
660000	1/8" i.g. x 1/8" i.g. x 1/8" i.g.	20,-
660202	1/4" i.g. x 1/4" i.g. x 1/4" i.g.	34,-
660404	3/8" i.g. x 3/8" i.g. x 3/8" i.g.	48,-
660505	1/2" i.g. x 1/2" i.g. x 1/2" i.g.	74,-

Pakket på blister/SB kort

Best nr.	Kr/stk
B660000	24,-
B660202	38,-
B660404	53,-
B660505	78,-



Best nr.	Beskrivelse	Kr/stk
661000	1/8" i.g. x 1/8" u.g. x 1/8" i.g.	19,-
661202	1/4" i.g. x 1/4" u.g. x 1/4" i.g.	30,-
661404	3/8" i.g. x 3/8" u.g. x 3/8" i.g.	46,-
661505	1/2" i.g. x 1/2" u.g. x 1/2" i.g.	72,-

Pakket på blister/SB kort

Best nr.	Kr/stk
B661000	23,-
B661202	35,-
B661404	50,-
B661505	77,-



Best nr.	Beskrivelse	Kr/stk
670000	1/8" i.g. x 1/8" i.g.	16,-
670202	1/4" i.g. x 1/4" i.g.	25,-
670404	3/8" i.g. x 3/8" i.g.	38,-
670505	1/2" i.g. x 1/2" i.g.	53,-

Pakket på blister/SB kort

Best nr.	Kr/stk
B670000	20,-
B670202	29,-



Best nr.	Beskrivelse	Kr/stk
671000	1/8" u.g. x 1/8" i.g.	15,-
671202	1/4" u.g. x 1/4" i.g.	22,-
671404	3/8" u.g. x 3/8" i.g.	29,-
671505	1/2" u.g. x 1/2" i.g.	47,-

Pakket på blister/SB kort

Best nr.	Kr/stk
B671000	19,-
B671202	26,-
B671404	34,-
B671505	51,-



Best nr.	Beskrivelse	Kr/stk
680000	1/8" i.g. x 1/8" i.g. x 1/8" i.g.	20,-
680202	1/4" i.g. x 1/4" i.g. x 1/4" i.g.	25,-
680404	3/8" i.g. x 3/8" i.g. x 3/8" i.g.	36,-
680505	1/2" i.g. x 1/2" i.g. x 1/2" i.g.	59,-

Pakket på blister/SB kort

Best nr.	Kr/stk
B680000	24,-
B680202	29,-
B680404	40,-
B680505	66,-



Best nr.	Beskrivelse	Kr/stk
681000	1/8" i.g. x 1/8" u.g. x 1/8" i.g.	20,-
681202	1/4" i.g. x 1/4" u.g. x 1/4" i.g.	26,-
681404	3/8" i.g. x 3/8" u.g. x 3/8" i.g.	38,-
681505	1/2" i.g. x 1/2" u.g. x 1/2" i.g.	63,-

Pakket på blister/SB kort

Best nr.	Kr/stk
B681000	24,-
B681202	30,-
B681404	42,-
B681505	67,-



Best nr.	Beskrivelse	Kr/stk
920812	08 - 12 mm	6,-
921016	10 - 16 mm	6,-
921222	12 - 22 mm	6,-
921627	16 - 27 mm	6,-
922335	23 - 35 mm	7,-
923045	30 - 45 mm	7,-
923250	32 - 50 mm	9,-
924060	40 - 60 mm	9,-
925070	50 - 70 mm	13,-
926080	60 - 80 mm	14,-
927090	70 - 90 mm	16,-
9280100	80 - 100 mm	14,-

Pakket på blister/SB kort

Best nr.	Kr/5 stk
B920812	41,-
B921016	42,-
B921222	43,-
B921627	43,-

SLANGEKLEMMER



Best nr.	Beskrivelse	Kr/stk
930305	3 - 5 mm	3,-
930507	5 - 7 mm	3,-
930709	7 - 9 mm	3,-
930911	9 - 11 mm	3,-
931113	11 - 13 mm	3,-
931315	13 - 15 mm	3,-
931517	15 - 18 mm	3,-
931720	17 - 20 mm	3,-
932023	20 - 23 mm	6,-
932027	23 - 27 mm	7,-
932528	25 - 28 mm	7,-
932831	28 - 31 mm	8,-
933134	31 - 34 mm	8,-
933437	34 - 37 mm	8,-
933740	37 - 40 mm	9,-
934043	40 - 43 mm	9,-
934346	43 - 46 mm	13,-

Pakket på blister/SB kort

Best nr.	Kr/5 stk
B930305	22,-
B930507	22,-
B930709	22,-
B930911	22,-
B931113	23,-
B931315	23,-
B931517	23,-
B931720	25,-



Best nr.	Beskrivelse	Kr/stk
940708	7,0 /8,5 x 7,4 mm	4,-
940809	8,0 /9,5 x 7,4 mm	4,-
940810	8,0 /10,0 x 7,4 mm	4,-
940911	9,1 /10,8 x 7,4 mm	4,-
941012	10,3 /12,3 x 7,4 mm	4,-
941113	11,1 /13,1 x 8,2 mm	4,-
941214	12,3 /14,3 x 8,2 mm	6,-
941416	14,6 /16,8 x 8,2 mm	6,-
941517	15,6 /17,8 x 8,2 mm	6,-

PUMPENIPLER TIL CYKEL ELLER BIL



Best nr.	Beskrivelse	Kr/stk
150110	Koblingsnippel - BIL	99,-
150111	Koblingsnippel - CYKEL	99,-
150112	Slangestuds - BIL	99,-
150113	Slangestuds - CYKEL	99,-

Pakket på blister/SB kort

Best nr.	Kr/stk
B150110	103,-
B150111	103,-
B150112	103,-
B150113	103,-



Best nr.	Beskrivelse	Kr/stk
B150503	Adaptersæt, cykel/båd/bold, pakket på blister	49,-



Best nr.	Beskrivelse	Kr/stk
700400	Lige union 4 mm x 1/8" i.g.	25,-
700402	Lige union 4 mm x 1/4" i.g.	27,-
700500	Lige union 5 mm x 1/8" i.g.	38,-
700600	Lige union 6 mm x 1/8" i.g.	23,-
700602	Lige union 6 mm x 1/4" i.g.	28,-
700800	Lige union 8 mm x 1/8" i.g.	24,-
700802	Lige union 8 mm x 1/4" i.g.	27,-
701002	Lige union 10 mm x 1/4" i.g.	38,-



Best nr.	Beskrivelse	Kr/stk
710405	Lige union 4 mm x M5 u.g.	19,-
710410	Lige union 4 mm x 1/8" u.g.	19,-
710412	Lige union 4 mm x 1/4" u.g.	20,-
710505	Lige union 5 mm x M5 u.g.	22,-
710510	Lige union 5 mm x 1/8" u.g.	19,-
710512	Lige union 5 mm x 1/4" u.g.	27,-
710605	Lige union 6 mm x M5 u.g.	19,-
710610	Lige union 6 mm x 1/8" u.g.	19,-
710612	Lige union 6 mm x 1/4" u.g.	21,-
710614	Lige union 6 mm x 3/8" u.g.	32,-
710615	Lige union 6 mm x 1/2" u.g.	41,-
710810	Lige union 8 mm x 1/8" u.g.	21,-
710812	Lige union 8 mm x 1/4" u.g.	21,-
710814	Lige union 8 mm x 3/8" u.g.	24,-
710815	Lige union 8 mm x 1/2" u.g.	42,-
711010	Lige union 10 mm x 1/8" u.g.	38,-
711012	Lige union 10 mm x 1/4" u.g.	25,-
711014	Lige union 10 mm x 3/8" u.g.	28,-
711015	Lige union 10 mm x 1/2" u.g.	42,-
711212	Lige union 12 mm x 1/4" u.g.	34,-
711214	Lige union 12 mm x 3/8" u.g.	34,-
711215	Lige union 12 mm x 1/2" u.g.	41,-
711414	Lige union 14 mm x 3/8" u.g.	63,-
711415	Lige union 14 mm x 1/2" u.g.	65,-



Best nr.	Beskrivelse	Kr/stk
720415	Vridbar vinkel 4 mm x M5 u.g.	36,-
720410	Vridbar vinkel 4 mm x 1/8" u.g.	36,-
720412	Vridbar vinkel 4 mm x 1/4" u.g.	38,-
720505	Vridbar vinkel 5 mm x M5 u.g.	36,-
720510	Vridbar vinkel 5 mm x 1/8" u.g.	38,-
720512	Vridbar vinkel 5 mm x 1/4" u.g.	42,-
720605	Vridbar vinkel 6 mm x M5 u.g.	36,-
720610	Vridbar vinkel 6 mm x 1/8" u.g.	34,-
720612	Vridbar vinkel 6 mm x 1/4" u.g.	36,-
720614	Vridbar vinkel 6 mm x 3/8" u.g.	49,-
720810	Vridbar vinkel 8 mm x 1/8" u.g.	38,-
720812	Vridbar vinkel 8 mm x 1/4" u.g.	40,-
720814	Drejelig vinkel 8 mm x 3/8" u.g.	47,-
721010	Vridbar vinkel 10 mm x 1/8" u.g.	49,-
721012	Vridbar vinkel 10 mm x 1/4" u.g.	47,-
721014	Vridbar vinkel 10 mm x 3/8" u.g.	51,-
721015	Vridbar vinkel 10 mm x 1/2" u.g.	72,-
721212	Vridbar vinkel 12 mm x 1/4" u.g.	62,-
721214	Vridbar vinkel 12 mm x 3/8" u.g.	68,-
721215	Vridbar vinkel 12 mm x 1/2" u.g.	71,-
721414	Vridbar vinkel 14 mm x 3/8" u.g.	78,-
721415	Vridbar vinkel 14 mm x 1/2" u.g.	82,-

PROP



Best nr.	Beskrivelse	Kr/stk
730400	Prop 4 mm	7,-
730500	Prop 5 mm	13,-
730600	Prop 6 mm	7,-
730800	Prop 8 mm	9,-
731000	Prop 10 mm	13,-
731200	Prop 12 mm	15,-
731400	Prop 14 mm	19,-

BASE



Best nr.	Beskrivelse	Kr/stk
730410	Base 4 mm x 1/8" u.g.	13,-
730412	Base 4 mm x 1/4" u.g.	14,-
730505	Base 5 mm x M5 u.g.	15,-
730510	Base 5 mm x 1/8" u.g.	15,-
730512	Base 5 mm x 1/4" u.g.	18,-
730610	Base 6 mm x 1/8" u.g.	9,-
730612	Base 6 mm x 1/4" u.g.	13,-
730810	Base 8 mm x 1/8" u.g.	9,-
730812	Base 8 mm x 1/4" u.g.	15,-
730814	Base 8 mm x 3/8" u.g.	16,-
731010	Base 10 mm x 1/8" u.g.	13,-
731012	Base 10 mm x 1/4" u.g.	15,-
731014	Base 10 mm x 3/8" u.g.	20,-
731214	Base 12 mm x 3/8" u.g.	34,-
731215	Base 12 mm x 1/2" u.g.	27,-
731414	Base 14 mm x 3/8" u.g.	27,-
731415	Base 14 mm x 1/2" u.g.	28,-

REDUKTION



Best nr.	Beskrivelse	Kr/stk
740604	Reduktion 6 mm u. x 4 mm i.	19,-
740605	Reduktion 6 mm u. x 5 mm i.	26,-
740804	Reduktion 8 mm u. x 4 mm i.	19,-
740806	Reduktion 8 mm u. x 6 mm i.	19,-
741006	Reduktion 10 mm u. x 6 mm i.	20,-
741008	Reduktion 10 mm u. x 8 mm i.	21,-
741208	Reduktion 12 mm u. x 8 mm i.	26,-
741210	Reduktion 12 mm u. x 10 mm i.	27,-
741408	Reduktion 14 mm u. x 8 mm i.	34,-
741410	Reduktion 14 mm u. x 10 mm i.	40,-
741412	Reduktion 14 mm u. x 12 mm i.	43,-

DOBBELT UNION



Best nr.	Beskrivelse	Kr/stk
750404	Dobbelt union 4 mm	29,-
750406	Dobbelt union 4 mm x 6 mm	36,-
750505	Dobbelt union 5 mm	38,-
750606	Dobbelt union 6 mm	30,-
750608	Dobbelt union 6 mm x 8 mm	42,-
750808	Dobbelt union 8 mm	34,-
750810	Dobbelt union 8 mm x 10 mm	50,-
751010	Dobbelt union 10 mm	47,-
751212	Dobbelt union 12 mm	60,-
751414	Dobbelt union 14 mm	82,-

T-STYKKE



Best nr.	Beskrivelse	Kr/stk
760404	T-stykke 4 mm	41,-
760505	T-stykke 5 mm	46,-
760606	T-stykke 6 mm	44,-
760808	T-stykke 8 mm	51,-
761010	T-stykke 10 mm	65,-
761212	T-stykke 12 mm	80,-
761414	T-stykke 14 mm	111,-

T-STYKKE



Best nr.	Beskrivelse	Kr/stk
760410	T-stykke 4 mm x 1/8" u.g. x 4 mm	47,-
760610	T-stykke 6 mm x 1/8" u.g. x 6 mm	49,-
760612	T-stykke 6 mm x 1/4" u.g. x 6 mm	51,-
760810	T-stykke 8 mm x 1/8" u.g. x 8 mm	57,-
760812	T-stykke 8 mm x 1/4" u.g. x 8 mm	59,-
761012	T-stykke 10 mm x 1/4" u.g. x 10 mm	78,-
761415	T-stykke 14 mm x 1/2" u.g. x 14 mm	111,-

VINKEL



Best nr.	Beskrivelse	Kr/stk
770404	Vinkel 4 mm	28,-
770505	Vinkel 5 mm	32,-
770606	Vinkel 6 mm	34,-
770808	Vinkel 8 mm	36,-
771010	Vinkel 10 mm	46,-
771212	Vinkel 12 mm	62,-
771414	Vinkel 14 mm	87,-

VINKEL DREJELIG



Best nr.	Beskrivelse	Kr/stk
780405	Vinkel drejelig 4 mm x M5 u.g.	44,-
780410	Vinkel drejelig 4 mm x 1/8" u.g.	48,-
780510	Vinkel drejelig 5 mm x 1/8" u.g.	49,-
780610	Vinkel drejelig 6 mm x 1/8" u.g.	49,-
780612	Vinkel drejelig 6 mm x 1/4" u.g.	68,-
780810	Vinkel drejelig 8 mm x 1/8" u.g.	50,-
780812	Vinkel drejelig 8 mm x 1/4" u.g.	67,-
780814	Vinkel drejelig 8 mm x 3/8" u.g.	87,-
781012	Vinkel drejelig 10 mm x 1/4" u.g.	70,-
781212	Vinkel drejelig 12 mm x 1/4" u.g.	88,-
781214	Vinkel drejelig 12 mm x 3/8" u.g.	91,-

KONTRA-/DRØVLEVENTIL



Best nr.	Beskrivelse	Kr/stk
790410	Kontra-/drøvleventil, 4 mm x 1/8" u.g.	107,-
790505	Kontra-/drøvleventil, 5 mm x M5 u.g.	107,-
790605	Kontra-/drøvleventil, 6 mm x M5 u.g.	108,-
790610	Kontra-/drøvleventil, 6 mm x 1/8" u.g.	107,-
790612	Kontra-/drøvleventil, 6 mm x 1/4" u.g.	122,-
790810	Kontra-/drøvleventil, 8 mm x 1/8" u.g.	107,-
790812	Kontra-/drøvleventil, 8 mm x 1/4" u.g.	122,-
790814	Kontra-/drøvleventil, 8 mm x 3/8" u.g.	277,-
791012	Kontra-/drøvleventil, 10mm x 1/4" u.g.	130,-

(Spørg for andre størrelser og materialer)

PA SLANGE



Best nr.	Beskrivelse	Kr/m
200004B	PA slange 4/2 mm blå	5,-
200004S	PA slange 4/2 mm sort	5,-
200004R	PA slange 4/2 mm rød	5,-
200004T	PA slange 4/2 mm transperant	5,-
200005B	PA slange 5/3 mm blå	9,-
200005R	PA slange 5/3 mm rød	9,-
200005T	PA slange 5/3 mm transperant	9,-
200006B	PA slange 6/4 mm blå	9,-
200006S	PA slange 6/4 mm sort	9,-
200006R	PA slange 6/4mm rød	9,-
200006T	PA slange 6/4mm transperant	9,-
200008B	PA slange 8/6 mm blå	15,-
200008S	PA slange 8/6 mm sort	15,-
200008R	PA slange 8/6 mm rød	15,-
200008T	PA slange 8/6 mm transperant	15,-
200010B	PA slange 10/8 mm blå	19,-
200010S	PA slange 10/8 mm sort	19,-
200010R	PA slange 10/8 mm rød	19,-
200010T	PA slange 10/8 mm transperant	19,-
200012B	PA slange 12/10 mm blå	24,-
200012S	PA slange 12/10 mm sort	24,-
200012R	PA slange 12/10 mm rød	24,-
200012T	PA slange 12/10 mm transperant	24,-
200014R	PA slange 14/11 mm rød	42,-
200014S	PA slange 14/11 mm sort	42,-
200014T	PA slange 14/11 mm transperant	42,-



PU SLANGE



Best nr.	Beskrivelse	Kr/m
270004B	PU slange 4/2 mm - blå	5,-
270004S	PU slange 4/2 mm - sort	5,-
270004R	PU slange 4/2 mm - rød	5,-
270004T	PU slange 4/2 mm - transperant	5,-
270005B	PU slange 5/3 mm - blå	8,-
270005S	PU slange 5/3 mm - sort	8,-
270005R	PU slange 5/3 mm - rød	8,-
270005T	PU slange 5/3 mm - transperant	8,-
270006B	PU slange 6/4 mm - blå	14,-
270006S	PU slange 6/4 mm - sort	14,-
270006R	PU slange 6/4 mm - rød	14,-
270006T	PU slange 6/4 mm - transperant	14,-
270008B	PU slange 8/6 mm - blå	18,-
270008S	PU slange 8/6 mm - sort	18,-
270008R	PU slange 8/6 mm - rød	18,-
270008T	PU slange 8/6 mm - transperant	18,-
270010B	PU slange 10/8 mm - blå	24,-
270010S	PU slange 10/8 mm - sort	24,-
270010R	PU slange 10/8 mm - rød	24,-
270010T	PU slange 10/8 mm - transperant	24,-
270012B	PU slange 12/9 mm - blå	43,-
270012S	PU slange 12/9 mm - sort	43,-
270012R	PU slange 12/9 mm - rød	43,-
270012T	PU slange 12/9 mm - transperant	43,-
270014R	PU slange 14/11 mm - blå	50,-
270014S	PU slange 14/11 mm - sort	50,-
270014T	PU slange 14/11 mm - transperant	50,-





Best nr.	Beskrivelse	Kr/stk
291210	Teflon gevindtape 12x0,75mm x 12m	13,-

Pakket på blister/SB kort

Best nr.	Kr/stk
B291210	17,-

KUGLEHANE & LYDDÆMPERE

KUGLEHANE



Best nr.	Beskrivelse	Kr/stk
470202	1/4" indv. gevind	51,-
470404	3/8" indv. gevind	50,-
470505	1/2" indv. gevind	63,-

Pakket på blister/SB kort

Best nr.	Kr/5 stk
B470202	57,-
B470404	56,-
B470505	69,-

KUGLEHANE



Best nr.	Beskrivelse	Kr/stk
471202	1/4" udv. x 1/4" indv. gevind	50,-
471404	3/8" udv. x 3/8" indv. gevind	49,-
471505	1/2" udv. x 1/2" indv. gevind	62,-
471707	3/4" udv. x 3/4" indv. gevind	86,-

Pakket på blister/SB kort

Best nr.	Kr/5 stk
B471202	56,-
B471404	55,-
B471505	68,-
B471707	92,-

LYDDÆMPER



Best nr.	Beskrivelse	Kr/stk
C870A210	1/8" gev.	17,-
C870A220	1/4" gev.	19,-
C870A230	3/8" gev.	29,-
C870A240	1/2" gev.	43,-
C870A250	3/4" gev.	57,-

LYDDÆMPER



Best nr.	Beskrivelse	Kr/stk
C870A310	1/8" gev.	20,-
C870A320	1/4" gev.	26,-
C870A330	3/8" gev.	48,-
C870A340	1/2" gev.	63,-
C870A350	3/4" gev	126,-



Best nr.	Beskrivelse	Kr/pr. 100
802102	2,5 mm x 100 mm	14,-
802165	2,5 mm x 165 mm	30,-
802200	2,5 mm x 203 mm	36,-
803140	3,2 mm x 142 mm	30,-
803200	3,6 mm x 200 mm	46,-
803292	3,6 mm x 292 mm	79,-
803370	3,6 mm x 368 mm	86,-
804160	4,8 mm x 160 mm	44,-
804200	4,8 mm x 203 mm	49,-
804250	4,8 mm x 250 mm	82,-
804290	4,8 mm x 280 mm	88,-
804370	4,8 mm x 368 mm	103,-
807200	7,6 mm x 200 mm	122,-
807240	7,6 mm x 240 mm	137,-
807370	7,6 mm x 380 mm	222,-
808450	8,0 mm x 450 mm	322,-
808550	8,0 mm x 550 mm	418,-
809168	9,0 mm x 1168 mm	1.661,-
809762	9,0 mm x 762 mm	686,-
810103	12,7 mm x 1030 mm	1.507,-
810550	13,0 mm x 550 mm	686,-



Best nr.	Beskrivelse	Kr/pr. 100
802102T	2,5 mm x 100 mm	14,-
802165T	2,5 mm x 165 mm	30,-
802200T	2,5 mm x 203 mm	36,-
803140T	3,2 mm x 142 mm	30,-
803200T	3,6 mm x 200 mm	46,-
803292T	3,6 mm x 292 mm	79,-
803370T	3,6 mm x 368 mm	86,-
804160T	4,8 mm x 160 mm	44,-
804200T	4,6 mm x 203 mm	49,-
804290T	4,8 mm x 280 mm	88,-
804370T	4,8 mm x 368 mm	103,-
807370T	7,6 mm x 380 mm	222,-
808550T	8,0 mm x 550 mm	418,-
810103T	12,7 mm x 1030 mm	1.507,-



Best nr.	Beskrivelse	Kr/stk
800001	500 stk. i metalbox	602,-
800002	500 stk. i metalboks + 500 refil	903,-
800004	2x500 stk. + kabelbindertang	2.074,-
800500	500 stk. refil pose	288,-
801000	1000 stk. i pose	569,-
801200	1200 stk. i pose	423,-



Best nr.	Beskrivelse	Kr/stk
800003	Kabelbindertang 2,2mm - 4,8mm	695,-



Best nr.	Beskrivelse	Kr/stk
980001	Værktøjsolie syrefri ISO32 - 1 ltr.	125,-



Best nr.	Beskrivelse	Kr/stk
980006	Kompressorolie P46 - 1 ltr.	125,-

SKUMPISTOLER "NBS"



Best nr.	Beskrivelse	Kr/stk
180200	NBS skumpistol m. ballofix	881,-
180207	Plastdyse for skumpistol	5,-
180101	Dyserør for skumpistol	161,-
180111	Yderdyse for skumpistol	30,-



Best nr.	Beskrivelse	Kr/stk
110605	Bodypistol t. 1 ltr. engangsemballage	202,-
110615	110605 m/hulrumsslange	295,-
110650	Dyse for bodypistol	57,-
110660	Hulrumsslange f. 110605/110615	96,-



Best nr.	Beskrivelse	Kr/stk
110610	Bodypistol t. 1 ltr. plastbeholder	224,-



Best nr.	Beskrivelse	Kr/stk
160610	m/1 ltr. engangsemballage	638,-
160615	m/hulrumsslange	512,-
160620	160610 m/hulrumsslange	585,-
160660	Hulrumsslange	134,-



Best nr.	Beskrivelse	Kr/stk
160605	m/stålbeholder, slange og håndtag	1.472,-
160635	Hulrumsslange m/nippel	274,-
160640	Hulrumsslange m/nippel og håndtag	274,-



Best nr.	Beskrivelse	Kr/stk
110701	Oliesuger	349,-

BREMSEUDLUFTER



Best nr.	Beskrivelse	Kr/stk
110310	m/1 ltr. plastbeholder	364,-
110350	Gummipibe	43,-
110370	Løs beholder	79,-
110380	Lyddæmper	79,-



Best nr.	Beskrivelse	Kr/stk
110210	1 ltr. beholder 200mm dyse	188,-



Best nr.	Beskrivelse	Kr/stk
151510	Tryksprøjte 24 ltr., Rustfri	5.177,-



Best nr.	Beskrivelse	Kr/stk
110810	Oliepåfylder 7,5 ltr. til automatgearkasse inkl. værktøjsæt, 11 dele	2.620,-

SANDBLÆSEPISTOLER



Best nr.	Beskrivelse	Kr/stk
110505	Sandblæsesæt med 3,0 m sugeslange	467,-



Best nr.	Beskrivelse	Kr/stk
110510	m/1 ltr. beholder	222,-
110550	Dyse for 110510	57,-



Best nr.	Beskrivelse	Kr/stk
160500	m/1 ltr. metalbeholder	715,-
160519	Dyse for 160500	128,-



Best nr.	Beskrivelse	Kr/stk
160510	Sandblæsesæt m/ 3 m slange	848,-

PUMPEPISTOLER



Best nr.	Beskrivelse	Kr/stk
150500	Ø63 mm manometer 0 - 12 bar	249,-



Best nr.	Beskrivelse	Kr/stk
150700	0-12 bar m/500mm slange testcertifikat medfølger	429,-



Best nr.	Beskrivelse	Kr/stk
150800	Digital 0-12 bar m/ 500mm slange testcertifikat medfølger	719,-



Best nr.	Beskrivelse	Kr/stk
150900	Digital pumpepistol 0-12 bar PRE-SET, 2m slange og klemnippel	1.795,-

Best nr.	Tilbehør til 150700/150800/150900	Kr/stk
150801	Komplet slange med klemnippel 500 mm	163,-
150802	Komplet slange med klemnippel 2 m	204,-
150803	Komplet slange med klemnippel 3 m	256,-
150805	Komplet slange med klemnippel 5 m	280,-
150810	Klemnippel for pumpepistol 1/4" indv. gev.	84,-
150812	Klemnippel vinklet for pumpepistol	91,-
150813	Klemnippel (entreprenør) 1/4" indv. gev.	84,-



Best nr.	Beskrivelse	Kr/stk
150531	Pumpehåndtag m/dobbelpn bil, lukket ventil	176,-
150532	Pumpehåndtag m/dobbelpn bil, åben ventil	176,-
150533	Pumpehåndtag kombi cykel/bil m. slangest.	497,-

KITSÆT



Best nr.	Beskrivelse	Kr/stk
150350	Kitsæt	295,-



Best nr.	Beskrivelse	Kr/stk
150300	Kitsæt	602,-

MALERPISTOLER



Best nr.	Beskrivelse	Kr/stk
150410	1 ltr. metal beholder 1,8mm dyse	395,-
<i>Professionel malerpistol:</i>		
306100	1 ltr. metal beholder 1,8mm dyse	1.025,-



Best nr.	Beskrivelse	Kr/stk
150400	1/2 ltr. plast beholder 1,8mm dyse	361,-
<i>Professionel malerpistol:</i>		
308100	1/2 ltr. plast beholder 1,8mm dyse	1.196,-



Best nr.	Beskrivelse	Kr/stk
002006R	6mm bøjet rør	85,-
002007R	6mm bøjet rør m/nippel	121,-
002008R	8mm bøjet rør	85,-
002009R	8mm bøjet rør m/nippel	101,-

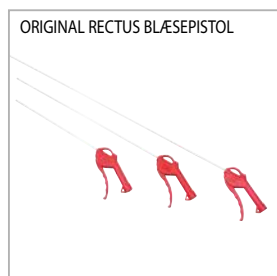

Best nr.	Beskrivelse	Kr/stk
002030R	8 x 300mm rør lige rød	103,-
002050R	8 x 500mm rør lige rød	109,-
002100R	8 x 1000mm rør lige rød	133,-



Best nr.	Beskrivelse	Kr/stk
001600	Blæsepistol Typhoon	353,-
001691	30/91 cm forlængerrør til 001600 pistol	176,-
001645	Dyse 45° til Typhoon pistol.	130,-
001660	Blæsepistol Cannon 60 cm rør	2.084,-

TYPHOON Pistolen giver 3 til 4 gange mere luft, end almindelige blæsepistoler
CANNON Pistolen giver 10 til 12 gange mere luft, end almindelige blæsepistoler



Best nr.	Beskrivelse	Kr/stk
002706	Prevost blæsepistol m/6 mm bøjet rør	145,-
002750	Prevost støjsvag blæsepistol, lydniveau: 77 dB, ridsefri kompositrør (I overensstemmelse med OSHA)	152,-



Best nr.	Beskrivelse	Kr/stk
001550	Ergonomisk støjsvag pistol, 77 dB	168,-
001560	Ergonomisk støjsvag pistol m/nippel, 77 dB	192,-



Best nr.	Beskrivelse	Kr/stk
002018R	Universal cykeladapter pistol	136,-
002018R-1	Messingkonus	23,-
002018R-2	Messingomløber	18,-
002018R-3	Gummikegle	53,-
140108	Blæsepistol til pumping af bolde	224,-



Alle de viste blæsepistoler leveres med 1/4" metalbøsning i tilslutningen

EKSTREM BLØD OG SMIDIG TRYKLUFT SLANGE

SUPER SOFT



Best nr.	Beskrivelse	Kr/stk
260410	3/8" x 10 m, med serie 1625 kobl/nippel	336,-
260410S	3/8" x 10 m, m/sikkerhedskobling/nippel	461,-
260420	3/8" x 20 m, med serie 1625 kobl/nippel	523,-
260420S	3/8" x 20 m, m/sikkerhedskobling/nippel	625,-

Best nr.	Beskrivelse	Kr/m
260450	3/8" x 50 m ruller	20,-
260550	1/2" x 50 m ruller	30,-

NITRIL SLANGE



Best nr.	Beskrivelse	Kr/stk
290410	3/8" x 10 m, med serie 1625 kobl/nippel	532,-
290420	3/8" x 20 m, med serie 1625 kobl/nippel	932,-

Best nr.	Beskrivelse	Kr/m
290250	1/4" Nitril stofarmeret, 50 m ruller	26,-
290450	3/8" Nitril stofarmeret, 50 m ruller	42,-

OLIE- & BENZIN SLANGE



Best nr.	Beskrivelse	Kr/m
250250	1/4" x 50 m ruller, 100°C	25,-
250450	3/8" x 50 m ruller, 100°C	29,-
250550	1/2" x 50 m ruller, 100°C	38,-
250750	3/4" x 50 m ruller, 100°C	59,-
250950	1" x 50 m ruller, 100°C	74,-

OLIE- & BENZIN SLANGE



Best nr.	Beskrivelse	Kr/stk
250410	3/8" x 10 m, med serie 1625 kobl/nippel	532,-
250410S	3/8" x 10 m, med serie 1625 kobl/sik. nippel	629,-
250420	3/8" x 20 m, med serie 1625 kobl/nippel	869,-
250420S	3/8" x 20 m, med serie 1625 kobl/sik. nippel	966,-
250510	1/2" x 10 m, med serie 1625 kobl/nippel	635,-
250520	1/2" x 20 m, med serie 1625 kobl/nippel	1.002,-

RECTUSOFT SLANGE



Best nr.	Beskrivelse	Kr/m
291150	6,3 x 11,0 mm Rectusoft, 50 m ruller	23,-
291550	9,0 x 14,5 mm Rectusoft, 50 m ruller	25,-
291950	12,7 x 19,0 mm Rectusoft, 50 m ruller	43,-

RECTUSOFT SLANGE



Best nr.	Beskrivelse	Kr/stk
291510	9 x 14,5 mm, med serie 1625 kobl/nippel	348,-
291520	9 x 14,5 mm, med serie 1625 kobl/nippel	532,-
291910	12,7 x 19,0 mm, med serie 1625 kobl/nippel	467,-
291920	12,7 x 19,0 mm, med serie 1625 kobl/nippel	796,-

PUR ARMERET SLANGE



Best nr.	Beskrivelse	Kr/m
261050	PUR armeret rød 6,5 x 10,0 mm, 50m	19,-
261050B	PUR armeret blå 6,5 x 10,0 mm, 50m	19,-
261250	PUR armeret rød 8,0 x 12,0 mm, 50m	23,-
261250B	PUR armeret blå 8,0 x 12,0 mm, 50m	23,-
261350	PUR armeret rød 9,5 x 13,0 mm, 50m	21,-
261350B	PUR armeret blå 9,5 x 13,0 mm, 50m	21,-
261450B	PUR armeret blå 10,0 x 14,5 mm, 50m	34,-
261850B	PUR armeret blå 13,0 x 18,0 mm, 50m	39,-

PUR ARMERET SLANGE



Best nr.	Beskrivelse	Kr/stk
261310B	3/8" x 10 m, med serie 1625 kobl/nippel	354,-
261310S	3/8" x 10 m m/sikkerhedskobling	450,-
261320B	3/8" x 20 m, med serie 1625 kobl/nippel	540,-
261320S	3/8" x 20 m m/sikkerhedskobling	636,-

KLAR PVC SLANGE



Best nr.	Beskrivelse	Kr/m
272250	Klar PVC slange 1/4", 50 m	9,-
272350	Klar PVC slange 5/16", 50 m	16,-
272450	Klar PVC slange 3/8", 50 m	17,-
272550	Klar PVC slange 1/2", 50 m	21,-
272750	Klar PVC slange 3/4", 50 m	32,-
272950	Klar PVC slange 1", 50 m	47,-
273225	Klar PVC slange 1 1/4", 25 m	82,-

KLAR ARMERET SLANGE



Best nr.	Beskrivelse	Kr/m
270250	Klar armeret PVC slange 1/4", 50 m	16,-
270350	Klar armeret PVC slange 5/16", 50 m	18,-
270450	Klar armeret PVC slange 3/8", 50 m	19,-
270550	Klar armeret PVC slange 1/2", 50 m	23,-
270750	Klar armeret PVC slange 3/4", 50 m	34,-
270950	Klar armeret PVC slange 1", 50 m	50,-
271025	Klar armeret PVC slange 1 1/4", 25 m	104,-
271125	Klar armeret PVC slange 1 1/2", 25 m	119,-

GRØN ÅNDEDRÆTSSLANGE IHT.
EN14594/EN14593



Best nr.	Beskrivelse	Kr/m
280450	Grøn åndedrætsslange 3/8", 50 m	80,-

Best nr.	Beskrivelse	Kr/stk.
280410	Forlængerslange 3/8" x 10m med 3/8" oml.	561,-
280415	Forlængerslange 3/8" x 15m med 3/8" oml.	815,-
280420	Forlængerslange 3/8" x 20m med 3/8" oml.	1.075,-
280425	Forlængerslange 3/8" x 25m med 3/8" oml.	1.325,-
280430	Forlængerslange 3/8" x 30m med 3/8" oml.	1.537,-





Best nr.	Slange dimension og arbejdslængde	Kr/stk
220802	5/8 mm x 2,5/2 m 1/4" udv.gev.	128,-
220805	5/8 mm x 5/4 m 1/4" udv.gev.	176,-
220807	5/8 mm x 7,5/6 m 1/4" udv.gev.	212,-
220810	5/8 mm x 10/8 m 1/4" udv.gev.	254,-
221002	6,5/10 mm x 2,5/2 m 1/4" udv.gev.	176,-
221005	6,5/10 mm x 5/4 m 1/4" udv.gev.	235,-
221007	6,5/10 mm x 7,5/6 m 1/4" udv.gev.	296,-
221010	6,5/10 mm x 10/8 m 1/4" udv.gev.	318,-

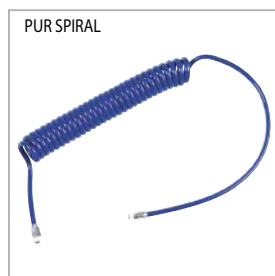

Best nr.	Slange dimension og arbejdslængde	Kr/stk
220802B	5/8 mm x 2,5/2 m 1/4" udv.gev.	128,-
220805B	5/8 mm x 5/4 m 1/4" udv.gev.	176,-
220807B	5/8 mm x 7,5/6 m 1/4" udv.gev.	212,-
220810B	5/8 mm x 10/8 m 1/4" udv.gev.	254,-
221002B	6,5/10 mm x 2,5/2 m 1/4" udv.gev.	176,-
221005B	6,5/10 mm x 5/4 m 1/4" udv.gev.	235,-
221007B	6,5/10 mm x 7,5/6 m 1/4" udv.gev.	296,-
221010B	6,5/10 mm x 10/8 m 1/4" udv.gev.	318,-
221202B	8/12 mm x 2,5/2 m 3/8" udv. gev.	248,-
221205B	8/12 mm x 5/4 m 3/8" udv. gev.	369,-
221207B	8/12 mm x 7,5/6 m 3/8" udv. gev.	439,-
221210B	8/12 mm x 10/8 m 3/8" udv. gev.	529,-

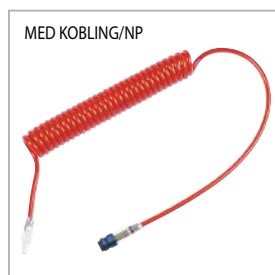

Best nr.	Slange dimension og arbejdslængde	Kr/stk
230802	5/8 mm x 2,5/2 m med serie 1625 kob./np.	281,-
230805	5/8 mm x 5/4 m med serie 1625 kob./np.	308,-
230807	5/8 mm x 7,5/6 m med serie 1625 kob./np.	348,-
230810	5/8 mm x 10/8 m med serie 1625 kob./np.	382,-
231002	6,5/10 mm x 2,5/2 m med serie 1625 kob./np.	308,-
231005	6,5/10 mm x 5/4 m med serie 1625 kob./np.	361,-
231007	6,5/10 mm x 7,5/6 m med serie 1625 kob./np.	410,-
231010	6,5/10 mm x 10/8 m med serie 1625 kob./np.	456,-

Spørg for andre slangedimensioner og farver.



Best nr.	Slange dimension og arbejdslængde	Kr/stk
230802B	5/8 mm x 2,5/2 m med serie 1625 kob./np.	281,-
230805B	5/8 mm x 5/4 m med serie 1625 kob./np.	308,-
230807B	5/8 mm x 7,5/6 m med serie 1625 kob./np.	348,-
230810B	5/8 mm x 10/8 m med serie 1625 kob./np.	382,-
231002B	6,5/10 mm x 2,5/2 m med serie 1625 kob./np.	308,-
231005B	6,5/10 mm x 5/4 m med serie 1625 kob./np.	361,-
231007B	6,5/10 mm x 7,5/6 m med serie 1625 kob./np.	410,-
231010B	6,5/10 mm x 10/8 m med serie 1625 kob./np.	456,-
231202B	8/12 mm x 2,5/2 m med serie 1625 kob./np.	348,-
231205B	8/12 mm x 5/4 m serie 1625 kob./np.	462,-
231207B	8/12 mm x 7,5/6 m serie 1625 kob./np.	529,-
231210B	8/12 mm x 10/8 m serie 1625 kob./np.	615,-



Best nr.	Slange dimension og arbejdslængde	Kr/stk
231002BS	6,5/10 mm x 7,5/6 m med sikkerhedskob./np.	404,-
231005BS	6,5/10 mm x 5/4 m med sikkerhedskob./np.	458,-
231007BS	6,5/10 mm x 7,5/6 m med sikkerhedskob./np.	506,-
231202BS	8/12 mm x 2,5/2 m med sikkerhedskob./np.	448,-
231205BS	8/12 mm x 5/4 m med sikkerhedskob./np.	580,-
231207BS	8/12 mm x 7,5/6 m med sikkerhedskob./np.	626,-

Monteret med vores nye sikkerhedskobling med trykknop.



Best nr.	Beskrivelse	Kr/stk
C376A300	Regulator 0-10 bar 1/4" tilslutninger	490,-
C374A300-3	Regulator 0-10 bar 3/8" tilslutninger	661,-
C374A300	Regulator 0-10 bar 1/2" tilslutninger	817,-
C370A300	Regulator 0-10 bar 3/4" tilslutninger	1.472,-
C370A400	Regulator 0-10 bar 1" tilslutninger	1.610,-



Best nr.	Beskrivelse	Kr/stk
C376A552	Filterregulator 0-10 bar 1/4"	702,-
C374A552-3	Filterregulator 0-10 bar 3/8"	949,-
C374A552	Filterregulator 0-10 bar 1/2"	1.111,-



Best nr.	Beskrivelse	Kr/stk
C376A252	Filter 25 my 1/4" tilslutning	460,-
C374A252-3	Filter 25 my 3/8" tilslutning	519,-
C374A252	Filter 25 my 1/2" tilslutning	587,-
C370A252	Filter 25 my 3/4" tilslutning	1.366,-
C328C103	Filter 25 my 1" tilslutning	1.460,-



Best nr.	Beskrivelse	Kr/stk
C376G450	Smøreapparat manuel 1/4"	561,-
C374G450-3	Smøreapparat manuel 3/8"	681,-
C374G450	Smøreapparat manuel 1/2"	831,-
C370G450	Smøreapparat manuel 3/4"	1.140,-
C348G101	Smøreapparat manuel 1"	1.614,-



Best nr.	Beskrivelse	Kr/stk
C368A732	Filterregulator, smøreapparat 1/4"	1.435,-
C368A432-3	Filterregulator, smøreapparat 3/8"	1.720,-
C368A432	Filterregulator, smøreapparat 1/2"	2.062,-
C368A032	Filterregulator, smøreapparat 3/4"	4.521,-
C368C503	Filterregulator, smøreapparat 1"	4.677,-



Best nr.	Beskrivelse	Kr/stk
V401010M	Ø40 mm 0-10 bar 1/8" gev.	45,-
C880A215	Ø40 mm 0-16 bar 1/8" gev.	105,-
V501012M	Ø50 mm 0-10 bar 1/4" gev.	57,-
C880A325	Ø50 mm 0-16 bar 1/4" gev.	105,-
C880A326	Ø50 mm 0-25 bar 1/4" gev.	105,-



Best nr.	Beskrivelse	Kr/stk
V901012M	Regulator 0-10 bar 1/4" tilslutninger	142,-
V901015M	Regulator 0-10 bar 1/2" tilslutninger	289,-



Best nr.	Beskrivelse	Kr/stk
V911012M	Filterregulator 0-10 bar 1/4"	295,-
V911015M	Filterregulator 0-10 bar 1/2"	415,-



Best nr.	Beskrivelse	Kr/stk
V941012M	Filterregulator og smøreapparat 1/4"	428,-
V941015M	Filterregulator og smøreapparat 1/2"	712,-

HØJTRYKSREGULATOR



Best nr.	Beskrivelse	Kr/stk
C359B201	Højtryksregulator 0-30 bar 1/4"	1.012,-
C359B202	Højtryksregulator 0-30 bar 1/2"	1.292,-



Best nr.	Beskrivelse	Kr/stk
C368A852	MFM finfilter 1 my 1/4" tilslutninger	2.550,-
C368A853	MFM finfilter 1 my 3/8" tilslutninger	2.615,-
C368A854	MFM finfilter 1 my 1/2" tilslutninger	2.762,-



Best nr.	Beskrivelse	Kr/stk
C368A962	MFB finfilter 0,01 my 1/4" tilslutninger	2.531,-
C368A963	MFB finfilter 0,01 my 3/8" tilslutninger	2.615,-
C368A964	MFB finfilter 0,01 my 1/2" tilslutninger	2.762,-



Best nr.	Beskrivelse	Kr/stk
C320A453	MFC Kulfilter 1/4"	2.310,-
C320A454	MFC Kulfilter 3/8"	2.462,-
C320A455	MFC Kulfilter 1/2"	2.714,-



Best nr.	Beskrivelse	Kr/stk
C320B227	Automatisk dræn for finfilter 1/4" - 1/2"	754,-



Best nr.	Beskrivelse	Kr/stk
C358A300	Vægbeslag for finfilter 1/4" - 1/2"	552,-



Best nr.	Beskrivelse	Kr/stk
C360A454	Koblingssæt for finfilter 1/4" - 1/2"	552,-

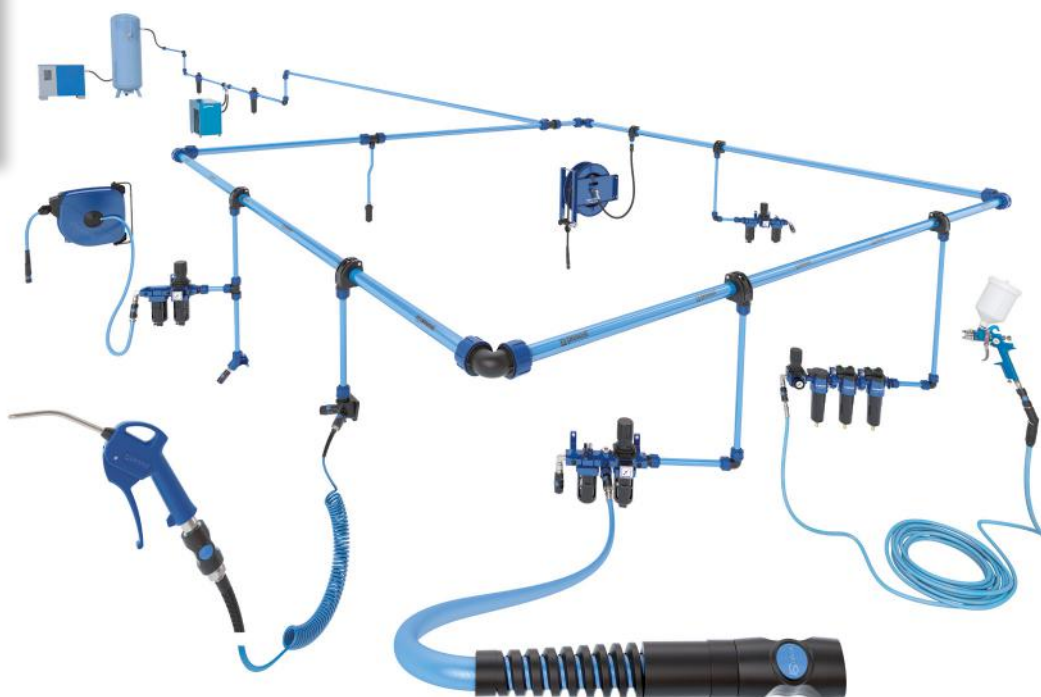

PREVOST alu rørsystem med tilhørende fittings.
Projekt og prisberegner kan rekvireres.

ALUMINIUMSRØR



Best nr.	Artikelnummer	Beskrivelse	Kr/stk
120002	ALR TU20L6	20 mm OD, 6 m Aluminiumsrør	449,-
120004	ALR TU25L6	25 mm OD, 6 m Aluminiumsrør	557,-
120006	ALR TU32L6	32 mm OD, 6 m Aluminiumsrør	771,-
120008	ALR TU40L6	40 mm OD, 6 m Aluminiumsrør	971,-
120010	ALR TU63L6	63 mm OD, 6 m Aluminiumsrør	1.716,-
120011	ALR TU80L6	80 mm OD, 6 m Aluminiumsrør	2.829,-

BØJET RØR



Best nr.	Artikelnummer	Beskrivelse	Kr/stk
121001	ALR LM20	20 mm OD, bøjet lang	215,-
121003	ALR LM25	25 mm OD, bøjet lang	221,-
122001	ALR LMC20	20 mm OD, bøjet kort	221,-
122003	ALR LMC25	25 mm OD, bøjet kort	231,-

FLANGE



Best nr.	Artikelnummer	Beskrivelse	Kr/stk
125070	ALR BP2520	Flange for 25 mm til 20 mm rør	261,-
125071	ALR BP3220	Flange for 32 mm til 20 mm rør	278,-
125072	ALR BP4020	Flange for 40 mm til 20 mm rør	314,-
125073	ALR BP4025	Flange for 40 mm til 25 mm rør	314,-
125076	ALR BP6320	Flange for 63 mm til 20 mm rør	422,-
125077	ALR BP6325	Flange for 63 mm til 25 mm rør	422,-
125078	ALR BP6332	Flange for 63 mm til 32 mm rør	422,-
125079	ALR BP8020	Flange for 80 mm til 20 mm rør	919,-
125080	ALR BP8025	Flange for 80 mm til 25 mm rør	919,-
125081	ALR BP8032	Flange for 80 mm til 32 mm rør	919,-

FLANGE



Best nr.	Artikelnummer	Beskrivelse	Kr/stk
125090	AVR BT2512	Flange for 25 mm til 1/2" indvendig gevind	288,-
125091	AVR BT3212	Flange for 32 mm til 1/2" indvendig gevind	307,-
125092	AVR BT4012	Flange for 40 mm til 1/2" indvendig gevind	344,-
125093	AVR BT4027	Flange for 40 mm til 3/4" indvendig gevind	383,-
125096	AVR BT6312	Flange for 63 mm til 1/2" indvendig gevind	483,-
125097	AVR BT6327	Flange for 63 mm til 3/4" indvendig gevind	483,-
125098	AVR BT6334	Flange for 63 mm til 1" indvendig gevind	485,-

LIGE UNION



Best nr.	Artikelnummer	Beskrivelse	Kr/stk
125000	ALR UN20	Lige union for 20 mm rør	93,-
125001	ALR UN25	Lige union for 25 mm rør	119,-
125002	ALR UN32	Lige union for 32 mm rør	172,-
125003	ALR UN40	Lige union for 40 mm rør	215,-
125005	ALR UNA63	Lige union alu. For 63 mm rør	742,-
125006	ALR UNA80	Lige union alu. For 80 mm rør	1.084,-

LIGE REDUKTION



Best nr.	Artikelnummer	Beskrivelse	Kr/stk
125010	ALR MR2520	Lige reduktion 25 mm til 20 mm	119,-
125011	ALR MR3225	Lige reduktion 32 mm til 25 mm	172,-
125012	ALR MR4032	Lige reduktion 40 mm til 32 mm	215,-

UNION 90°



Best nr.	Artikelnummer	Beskrivelse	Kr/stk
125030	ALR 9C20	Union 90° for 20 mm rør	103,-
125031	ALR 9C25	Union 90° for 25 mm rør	132,-
125032	ALR 9C32	Union 90° for 32 mm rør	188,-
125033	ALR 9C40	Union 90° for 40 mm rør	215,-
125035	ALR 9CA63	Union 90° alu. for 63 mm rør	856,-
125036	ALR 9CA80	Union 90° alu. for 80 mm rør	1.202,-

UNION 45°



Best nr.	Artikelnummer	Beskrivelse	Kr/m
125020	ALR 4C20	Union 45° for 20 mm rør	103,-
125021	ALR 4C25	Union 45° for 25 mm rør	132,-
125022	ALR 4C32	Union 45° for 32 mm rør	188,-
125023	ALR 4C40	Union 45° for 40 mm rør	215,-

PROP



Best nr.	Artikelnummer	Beskrivelse	Kr/stk
125400	ALR BO30	Prop for 20 mm rør	102,-
125401	ALR BO35	Prop for 25 mm rør	111,-
125402	ALR BO32	Prop for 32 mm rør	161,-
125403	ALR BO40	Prop for 40 mm rør	194,-
125405	ALR BOA63	Prop alu. for 63 mm rør	727,-
125406	ALR BOA80	Prop alu. for 80 mm rør	876,-

T-STYKKE



Best nr.	Artikelnummer	Beskrivelse	Kr/m
125040	ALR TE20	T-stykke for 20 mm rør	145,-
125041	ALR TE25	T-stykke for 25 mm rør	179,-
125042	ALR TE32	T-stykke for 32 mm rør	217,-
125043	ALR TE40	T-stykke for 40 mm rør	298,-
125045	ALR TEA63	T-stykke alu. for 63 mm rør	1.256,-
125046	ALR TEA80	T-stykke alu. for 80 mm rør	1.639,-

T-STYKKE



Best nr.	Artikelnummer	Beskrivelse	Kr/stk
125050	ALR TR2520	T-stykke reduktion 25 mm til 20 mm	176,-
125051	ALR TR3220	T-stykke reduktion 32 mm til 20 mm	217,-
125052	ALR TR3225	T-stykke reduktion 32 mm til 25 mm	217,-
125053	ALR TR4025	T-stykke reduktion 40 mm til 25 mm	298,-
125054	ALR TR4032	T-stykke reduktion 40 mm til 32 mm	298,-

T-STYKKE



Best nr.	Artikelnummer	Beskrivelse	Kr/stk
125060	ALR TT2012	T-stykke for 20 mm rør x 1/2" i.g	236,-
125061	ALR TT2512	T-stykke for 25 mm rør x 1/2" i.g	239,-

KOBLING



Best nr.	Artikelnummer	Beskrivelse	Kr/stk
125100	ALR PM2012	Kobling for 20 mm rør x 1/2" u.g	65,-
125101	ALR PM2027	Kobling for 20 mm rør x 3/4" u.g	65,-
125102	ALR PM2512	Kobling for 25 mm rør x 1/2" u.g	92,-
125103	ALR PM2527	Kobling for 25 mm rør x 3/4" u.g	92,-
125104	ALR PM2534	Kobling for 25 mm rør x 1" u.g	92,-
125105	ALR PM3234	Kobling for 32 mm rør x 1" u.g	103,-
125106	ALR PM3242	Kobling for 32 mm rør x 1 1/4" u.g	103,-
125107	ALR PM4042	Kobling for 40 mm rør x 1 1/4" u.g	132,-
125108	ALR PM4049	Kobling for 40 mm rør x 1 1/2" u.g	132,-

KOBLING



Best nr.	Artikelnummer	Beskrivelse	Kr/stk
125200	ALR MM2012	Kobling for 20 mm rør x 1/2" u.g metal	371,-
125201	ALR MM2027	Kobling for 20 mm rør x 3/4" u.g metal	309,-
125202	ALR MM2534	Kobling for 25 mm rør x 1" u.g metal	384,-
125203	ALR MM3242	Kobling for 32 mm rør x 1 1/4" u.g metal	610,-
125204	ALR MM4049	Kobling for 40 mm rør x 1 1/2" u.g metal	799,-

KOBLING



Best nr.	Artikelnummer	Beskrivelse	Kr/stk
125300	ALR MF2012	Kobling for 20 mm rør x 1/2" i.g metal	368,-
125301	ALR MF2027	Kobling for 20 mm rør x 3/4" i.g metal	368,-
125302	ALR MF2534	Kobling for 25 mm rør x 1" i.g metal	384,-

SVIRVEL MUFFE



Best nr.	Beskrivelse	Kr/stk
443333	Svirvel muffe 1" indvendig x 1" i.g	311,-
443434	Svirvel muffe 1 1/4" indvendig x 1 1/4" i.g	466,-
443535	Svirvel muffe 1 1/2" indvendig x 1 1/2" i.g	568,-
443636	Svirvel muffe 2" indvendig x 2" i.g	794,-

Y-STYKKE



Best nr.	Artikelnummer	Beskrivelse	Kr/stk
125500	ALR Y20	Y-stykke for 20 mm rør 2 x 1/2" i.g	443,-
125501	ALR Y25	Y-stykke for 25 mm rør 2 x 1/2" i.g	470,-
125502	ALR YP20	Y-stykke for 20 mm rør 2 x 1/2" i.g m/dræn	515,-
125503	ALR YP25	Y-stykke for 25 mm rør 2 x 1/2" i.g m/dræn	542,-

Y-STYKKE



Best nr.	Artikelnummer	Beskrivelse	Kr/stk
125600	AVR Y1212	Y-stykke med 1/2" i. g og 2 x 1/2" i. g	448,-
125601	AVR Y2712	Y-stykke med 3/4" i. g og 2 x 1/2" i. g	343,-

KUGLEHANE



Best nr.	Beskrivelse	Kr/stk
470505L	Kuglehane med 1/2" i.g	78,-
470707L	Kuglehane med 3/4" i.g	166,-
470909L	Kuglehane med 1" i.g	177,-
473434L	Kuglehane med 1 1/4" i.g	438,-

HAGENØGLE



Best nr.	Beskrivelse	Kr/stk
126016	Hagenøgle for omløber 20-32 mm (7)	224,-
126017	Hagenøgle for omløber 40-63 mm (7)	712,-

VÆGKONSOL



Best nr.	Beskrivelse	Kr/stk
125700	Vægkonsol for 20 mm rør max. afstand 3 m	20,-
125701	Vægkonsol for 25 mm rør max. afstand 3,5 m	25,-
125702	Vægkonsol for 32 mm rør max. afstand 4 m	37,-
125703	Vægkonsol for 40 mm rør max. afstand 4 m	42,-
125705	Vægkonsol for 63 mm rør max. afstand 4 m	49,-
125706	Vægkonsol for 80 mm rør max. afstand 4 m	174,-

LOFT-/VÆGKONSOL



Best nr.	Beskrivelse	Kr/stk
125800	Loft/vægkonsol for 20 mm rør max. afstand 3 m	21,-
125801	Loft/vægkonsol for 25 mm rør max. afstand 3,5 m	21,-
125802	Loft/vægkonsol for 32 mm rør max. afstand 4 m	22,-
125803	Loft/vægkonsol for 40 mm rør max. afstand 4 m	23,-
125805	Loft/vægkonsol for 63 mm rør max. afstand 4 m	22,-
125806	Loft/vægkonsol for 80 mm rør max. afstand 4 m	32,-

METAL SUPPORT



Best nr.	Beskrivelse	Kr/stk
125900	180 mm	65,-
125901	300 mm	76,-
125902	420 mm	86,-
125903	Skrue M8 for rørsupport	21,-

RØRCLIPS



Best nr.	Beskrivelse	Kr/stk
125904	Rørclips 3-8 mm (1)	41,-
125905	Rørclips 8-14 mm (1)	42,-
125906	Rørclips 14-20 mm (1)	43,-
125907	Rørclips 0-16 mm (2)	38,-



Et udpluk af unikke produkter fra **PREVOST**
EUROPÆISK TOP KVALITET

Varenr.	Tilslutning	Tankstr.	Cylinder	Cylindertype	Smørring	Motorydelse	Omdrejninger	Slagvolum	Eff. ydelse	Max tryk	Vægt	Dimension	Kr/stk.
K190/6	230 Volt	6 liter	1	Alu.	Oliefri	1,5 Hp	2850	151 l/min	90 l/min	8 bar	10 Kg	530 x 210 x 540 mm	2.223,-
K310/10	230 Volt	10 liter	1	Støbejern	Oliesmurt	2,5 Hp	2850	285 l/min	170 l/min	10 bar	30 Kg	480 x 510 x 550 mm	5.148,-
K230/24	230 Volt	24 liter	1	Støbejern+alu. top	Oliesmurt	2 Hp	2850	214 l/min	130 l/min	8 bar	26 Kg	600 x 255 x 590 mm	2.099,-
K230/50	230 Volt	50 liter	1	Støbejern+alu. top	Oliesmurt	2 Hp	2850	214 l/min	130 l/min	8 bar	36 Kg	810 x 300 x 680 mm	3.219,-
K90/3M	230 Volt	90 liter	2	Støbejern	Oliesmurt	3 Hp	1500	345 l/min	225 l/min	10 bar	69 Kg	1000 x 410 x 900 mm	6.625,-
K90/4T	400 Volt	90 liter	2	Støbejern	Oliesmurt	4 Hp	1450	400 l/min	300 l/min	10 bar	80 Kg	1000 x 410 x 910 mm	8.315,-
K90/5T	400 Volt	90 liter	2	Støbejern	Oliesmurt	5,5 Hp	1450	500 l/min	400 l/min	10 bar	104 Kg	1000 x 410 x 980 mm	11.227,-



K190/6



K310/10



K230/24



K230/50



K90/3M



K90/4T



K90/5T



Best nr.	Beskrivelse	Kr/stk
KV90CE	90 liter vertikal kompressor tank, max tryk 11 bar. Inkl. 0,5m slange, sikkerhedsventil og manometer	4.333,-

STØJSVAG KOMPRESSOR

Varenr.	Tilslutning	Tankstr.	Cylinder	Cylindertype	Smørring	Motorydelse	Slagvolum	Eff. ydelse	Max tryk	Vægt	Dimension	Kr/stk.
KP50/24	230 Volt	24 liter	1	Alu.	Oliesmurt	0,5 Hp	63 l/min	43 l/min	8 bar	21 Kg	490 x 460 x 570 mm	8.710,-



KP50/24

Oliesmurt kompressor ...

Husk olieskift efter de første 100 timers drift og efterfølgende efter hver 300 timers drift.

Vælg den rigtige kompressor ...

Anvendelsesgraden af vore kompressorer er ca. 50%, hvilket betyder, at kompressoren skal have en pause, der svarer til den periode, den er i drift. Eksempelvis 3 min. drift efterfulgt af 3 min. pause. Man bør derfor vælge den kompressor, der leverer ca. det dobbelte af ens behov. Det gennemsnitlige luftbehov for en standard 3/8" skraldenøgle er f.eks. 65 ltr./min., så for optimal drift bør man derfor vælge en kompressor, der leverer ca. 130 ltr./min.



Best nr.	Beskrivelse	Kr/stk
R2177	Slagnøgle 3/8" 580 Nm	2.924,-



Best nr.	Beskrivelse	Kr/stk
R2205	Slagnøgle 1/2" 580 Nm	1.750,-
R2267	Slagnøgle 1/2" 660 Nm	2.925,-
R2277	Slagnøgle 1/2" 1250 Nm	2.345,-



Best nr.	Beskrivelse	Kr/stk
R2315	Slagnøgle 3/4" 1500 Nm	4.937,-
R2377	Slagnøgle 3/4" 1950 Nm	6.250,-



Best nr.	Beskrivelse	Kr/stk
R2405	Slagnøgle 1" 1950 Nm	7.870,-
R2437XI	Slagnøgle 1" 2700 Nm	11.998,-



Best nr.	Beskrivelse	Kr/stk
R2477XI	Slagnøgle 1" lang hals 2900 Nm	9.385,-
R2457XI	Slagnøgle 1" kort hals 2900 Nm	9.385,-



Best nr.	Beskrivelse	Kr/stk
R4500	Boremaskine med revers 10 mm	1.781,-



Best nr.	Beskrivelse	Kr/stk
R7011	Ligesliber	512,-



Best nr.	Beskrivelse	Kr/stk
R7107	Vinkelligesliber	1.086,-



Best nr.	Beskrivelse	Kr/stk
R6050	Pladesav	1.537,-
R6067	Pladesav HD	3.852,-



Best nr.	Beskrivelse	Kr/stk
R6700	Blindnittepistol op til 5 mm	1.315,-
R6710	Blindnittepistol op til 6,4 mm	4.716,-
R6715	Blindnittepistol op til 6,4 mm	3.725,-
R6718XI	Blindnittepistol op til 6,4 mm	7.404,-



Best nr.	Beskrivelse	Kr/stk
R3060	Luftskele 1/4" Komposit	1.607,-
R3260	Luftskele 3/8" Komposit	1.630,-
R3600RE	Luftskele 1/2" inkl. DUS 21	1.210,-



Best nr.	Beskrivelse	Kr/stk
R5120	Mejselhammersæt 6J	1.035,-

Spørg venligst efter andre produkter i vores brede program indenfor RODCRAFT luftværktøj og værkstedsudstyr.

Vi forhandler også FUJI luftværktøjer



Best nr.	Beskrivelse	Kr/stk
490016	0,4 - 1,0 kg - 1,6 mtr.	348,-
490116	1,0 - 2,0 kg - 1,6 mtr.	375,-
490316	2,0 - 3,0 kg - 1,6 mtr.	397,-
490204	2,0 - 4,0 kg - 2,5 mtr.	960,-
490602	4,0 - 6,0 kg - 2,5 mtr.	987,-
490802	6,0 - 8,0 kg - 2,5 mtr.	1.097,-
491002	8,0 - 10,0 kg - 2,5 mtr.	1.152,-
491402	10,0 - 14,0 kg - 2,5 mtr.	1.208,-

ENERGI BOKS - 2 LUFTKOBLINGER & 3 STRØMUDTAG



Best nr.	Beskrivelse	Kr/stk
499033	3 m kabel/slange	2.892,-



claber

QUICK-CLICK LYNKOBLING

Yderst praktisk og max holdbarhed: Claber design på højeste niveau i den nye Quick-Click serie, med eller uden vandstop. Rustfri (ingen metal dele) og stødsikkert design. Resistente overfor UV stråler og kan samtidig holde til et stort tryk (op til 40 bars sprængningstryk, som er langt over det normale brugs vandtryk). Den interne fjeder – endnu et eksklusivt Claber patent – gør at lynkoblingen kan holde til 1,5 million "tilkoblinger" uden problemer. På grund af den internationale koblingsprofil kan Quick-Click serien anvendes sammen med andre gængse mærker på markedet.

Plastik materiale som er resistent overfor påvirkninger fra barskt vejr og UV stråler.

Fejlfri vandtæt pakning selv efter 1 million tilkoblinger.

Ergonomisk design til mindste detalje.

SE CLABER I SEPERAT KATALOG



Best nr.	Beskrivelse	TUN nr.	Pk. Str.	Kr/stk
2010000	15 L El rygsprøjte	1722465	1	1.387,-



Best nr.	Beskrivelse	TUN nr.	Pk. Str.	Kr/stk
2011000	15 L Rygsprøjte	1721394	1	425,-



Best nr.	Beskrivelse	TUN nr.	Pk. Str.	Kr/stk
2012000	5 L Håndsprøjte	1721409	1	123,-



Best nr.	Beskrivelse	TUN nr.	Pk. Str.	Kr/stk
2013000	2 L Håndsprøjte	1722464	1	59,-





SERIE 805										
Dimension	Lgd. (m)	Slange	Medie	Max. tryk	Tilslutning	Afgang	Vægt	Best nr.	Pris	
3/8"	10	polymer	luft/vand	20 bar	indv. 3/8"	udv. 3/8"	16 kg	E805103-N	835,-	
								Vægbeslag drejelig 140°	E800809	214,-

- Teknisk beskrivelse
 * Epoxy pulverlakeret overfladebehandling
 * Styream med 4 retningsruller, justerbar i 9 forskellige positioner
 * Monteret med polymer slange - max. temperatur 50°C
 * Tyndere godstykke og svirvel end serie 809

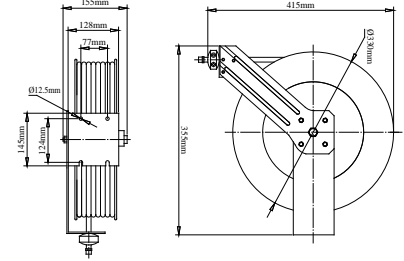

SERIE 809										
Dimension	Lgd. (m)	Slange	Medie	Max. tryk	Tilslutning	Afgang	Vægt	Best nr.	Pris	
1/4"	10	gummi	luft/vand	20 bar	indv. 1/4"	udv. 1/4"	13 kg	E809102	1.461,-	
3/8"	10	gummi	luft/vand	20 bar	indv. 3/8"	udv. 3/8"	14 kg	E809103	1.495,-	
10/14,5 mm	12	PUR	luft	20 bar	indv. 3/8"	udv. 3/8"	15 kg	E809123	1.570,-	
								Vægbeslag drejelig 140°	E800809	214,-

- Teknisk beskrivelse
 * Epoxy pulverlakeret overfladebehandling
 * Styream med 4 retningsruller, justerbar i 9 forskellige positioner
 * Monteret med SBR gummislange - max. temperatur 60°C
 * E809123 monteret med PUR slange

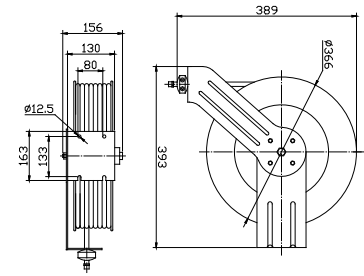

SERIE 810										
Dimension	Lgd. (m)	Slange	Medie	Max. tryk	Tilslutning	Afgang	Vægt	Best nr.	Pris	
3/8"	15	polymer	luft	20 bar	indv. 3/8"	udv. 3/8"	?? kg	E810153	895,-	

- Teknisk beskrivelse
 * Kombineret plast/metalruller
 * Styream med 4 retningsruller, justerbar i 9 forskellige positioner
 * Monteret med Polymer slange - max. temperatur 50°C

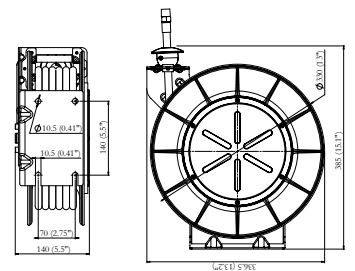

SERIE 820										
Dimension	Lgd. (m)	Slange	Medie	Max. tryk	Tilslutning	Afgang	Vægt	Best nr.	Pris	
3/8"	15	gummi	luft/vand	20 bar	indv. 3/8"	udv. 3/8"	22 kg	E820153	2.754,-	
1/2"	15	gummi	luft/vand	20 bar	indv. 1/2"	udv. 1/2"	23 kg	E820154	3.082,-	
								Vægbeslag drejelig 140°	E800820	214,-

- Teknisk beskrivelse
 * Epoxy pulverlakeret overfladebehandling
 * Styream med 4 retningsruller, justerbar i 9 forskellige positioner
 * Monteret med SBR gummislange - max. temperatur 60°C

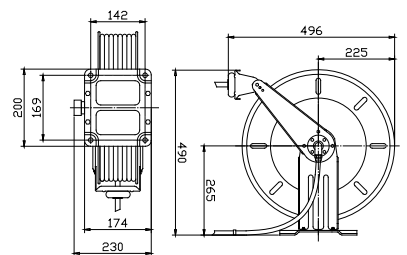



SERIE 820									
Dimension	Lgd. (m)	Slange	Medie	Max. tryk	Tilslutning	Afgang	Vægt	Best nr.	Pris
3/8"	15	gummi	luft/vand	20 bar	indv. 3/8"	udv. 3/8"	22 kg	E820153S	1.995,-
1/2"	15	gummi	luft/vand	20 bar	indv. 1/2"	udv. 1/2"	23 kg	E820154S	2.295,-
Vægbeslag drejelig 140°							2,5 kg	E800820	214,-

Teknisk beskrivelse
 * Epoxy pulverlakeret overfladebehandling
 * Styrearm med 4 retningsruller, justerbar i 9 forskellige positioner
 * Monteret med SBR gummislange - max. temperatur 60°C

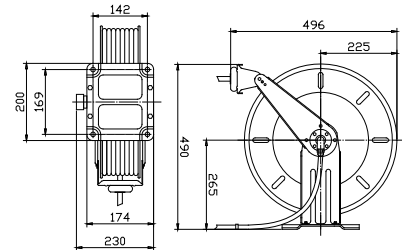

SERIE 801									
Dimension	Lgd. (m)	Slange	Medie	Max. tryk	Tilslutning	Afgang	Vægt	Best nr.	Pris
3/8"	20	polymer	luft/vand	20 bar	indv. 3/8"	udv. 3/8"	22 kg	E801203	1.465,-
1/2"	20	polymer	luft/vand	20 bar	indv. 1/2"	udv. 1/2"	26 kg	E801204	1.570,-
Vægbeslag drejelig 140°							2,5 kg	E800820	214,-

Teknisk beskrivelse
 * Epoxy pulverlakeret overfladebehandling
 * Styrearm med 4 retningsruller, justerbar i 9 forskellige positioner
 * Monteret med polymer slange - max. temperatur 50°C
 * Tyndere godstykkelse og svivel end serie 808

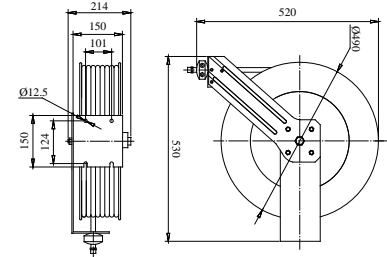

SERIE 808									
Dimension	Lgd. (m)	Slange	Medie	Max. tryk	Tilslutning	Afgang	Vægt	Best nr.	Pris
3/8"	20	gummi	luft/vand	20 bar	indv. 3/8"	udv. 3/8"	26 kg	E808203	2.266,-
1/2"	20	gummi	luft/vand	20 bar	indv. 1/2"	udv. 1/2"	31 kg	E808204	2.695,-
Vægbeslag drejelig 140°							2,5 kg	E800808	214,-

Højtryk									
Dimension	Lgd. (m)	Slange	Medie	Max. tryk	Tilslutning	Afgang	Vægt	Best nr.	Pris
3/8"	20	gummi	vand/hydraulik	276 bar	indv. 3/8"	udv. 3/8"	35 kg	EH808203-VI	3.749,-
3/8"	20	u/slange	vand/hydraulik	276 bar	indv. 3/8"	-	22 kg	EH808203W/O-VI	3.045,-

Teknisk beskrivelse
 * Epoxy pulverlakeret overfladebehandling
 * Styrearm med 4 retningsruller, justerbar i 9 forskellige positioner
 * Monteret med SBR gummislange - max. temperatur 60°C
 * Højtryksopruller - max. temperatur 120°C

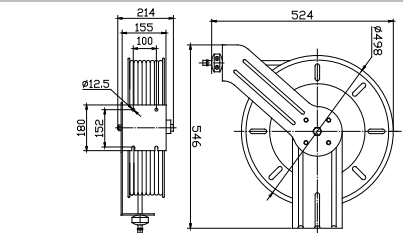

SERIE 880									
Dimension	Lgd. (m)	Slange	Medie	Max. tryk	Tilslutning	Afgang	Vægt	Best nr.	Pris
1/2"	30	gummi	luft/vand	20 bar	indv. 1/2"	udv. 1/2"	56 kg	E880304	6.195,-
3/4"	20	gummi	luft/vand	20 bar	indv. 3/4"	udv. 3/4"	58 kg	E880206	6.195,-
1"	15	gummi	luft/vand	20 bar	indv. 1"	udv. 1"	60 kg	E880158	6.195,-
Vægbeslag drejelig 140°							2,5 kg	E800880	1.133,-

Teknisk beskrivelse
 * Epoxy pulverlakeret overfladebehandling
 * Styrearm med 4 retningsruller, justerbar i 9 forskellige positioner
 * Monteret med SBR gummislange - max. temperatur 60°C

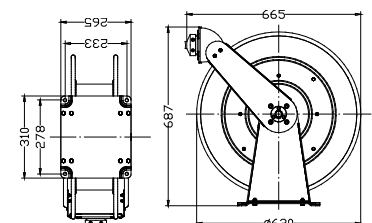



SERIE EW808										
Dimension	Lgd. (m)	Slange	Medie	Max. tryk	Tilslutning	Afgang	Vægt	Best nr.	Pris	
2x1/4"	20	gummi	oxygen - acetylene	20 bar	indv. 3/8"	udv. 3/8"	28 kg	EW8082022	3.697,-	

- Teknisk beskrivelse
- * Epoxy pulverlakeret overfladebehandling
 - * Styream med 4 retningsruller, justerbar i 9 forskellige positioner
 - * Dobbeltvirvel 1/4" højre/venstre udvendig gevind
 - * Slanger bør skiftes 1 gang om året

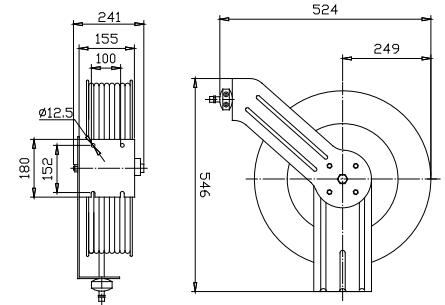

SERIE 250/300 I PULVERLAKERET											
Dimension	Lgd. (m)	Slange	Medie	Max. tryk	Tilslutning	Afgang	Vægt	Best nr.	Str.	Pris	
10/14,5 mm	10	PUR	luft/vand	20 bar	udv. 3/8"	udv. 3/8"	7 kg	I42608/12	1	2.348,-	
8/12 mm	15	PUR	luft/vand	20 bar	udv. 3/8"	udv. 1/4"	8 kg	I43108/13	2	2.574,-	
8/12 mm	20	PUR	luft/vand	20 bar	udv. 3/8"	udv. 1/4"	10 kg	I43108/14	2	2.834,-	
10/14,5 mm	15	PUR	luft/vand	20 bar	udv. 3/8"	udv. 3/8"	10 kg	I43108/16	2	2.889,-	

DIMENSION										
Str.	A	B	C	D	E	F	G	H	I	
1	281	338	230	173	124	62	40	fra 130 til 210		319
2	330	416	308	174	124	62	40	fra 130 til 210		319

- Teknisk beskrivelse
- * Boks i pulverlakeret stål med drejeligt væg-/loftbeslag
 - * Låser automatisk slangen ved ønsket længde
 - * Monteret med PUR slange

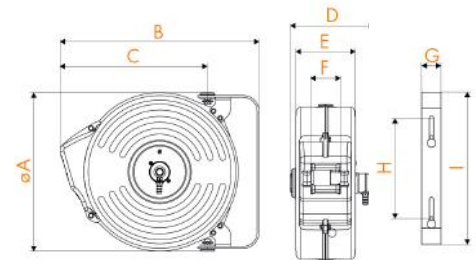

SERIE 710										
Dimension	Lgd. (m)	Slange	Medie	Max. tryk	Tilslutning	Afgang	Vægt	Best nr.	Pris	
8/12mm	7	PUR	luft	12 bar	udv.3/8"	udv. 3/8"	5 kg	E710073	551,-	

- Teknisk beskrivelse
- * Boks i slagfast polypropylene med drejeligt væg-/loftbeslag
 - * Låser automatisk slangen ved ønsket længde
 - * Monteret med PUR armeret slange

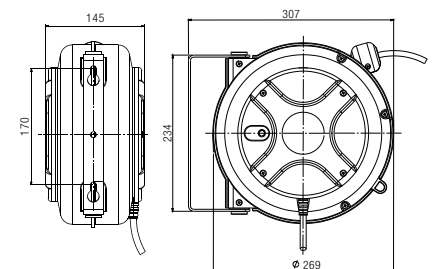

SERIE 705										
Dimension	Lgd. (m)	Slange	Medie	Max. tryk	Tilslutning	Afgang	Vægt	Best nr.	Pris	
6,5/10mm	10	PUR	luft	12 bar	udv. 1/4"	udv. 1/4"	5 kg	E705102	968,-	
8/12mm	8	PUR	luft	12 bar	udv. 1/4"	udv. 1/4"	5 kg	E705083	968,-	

- Teknisk beskrivelse
- * Boks i slagfast polypropylene med drejeligt væg-/loftbeslag
 - * Låser automatisk slangen ved ønsket længde
 - * Monteret med PUR armeret slange

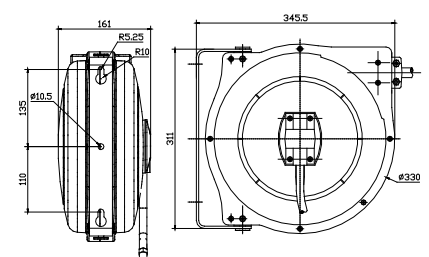



SERIE 730									
Dimension	Lgd. (m)	Slange	Medie	Max. tryk	Tilslutning	Afgang	Vægt	Best nr.	Pris
3/8"	10	PUR	luft	20 bar	udv. 3/8"	udv. 3/8"	4 kg	E733103	835,-
3/8"	15	PUR	luft	20 bar	udv. 3/8"	udv. 3/8"	6 kg	E735153	1.045,-

Teknisk beskrivelse
 * Boks i slagfast polypropylene med drejeligt væg-/loftbeslag
 * Låser automatisk slangen ved ønsket længde
 * Monteret med PUR slange

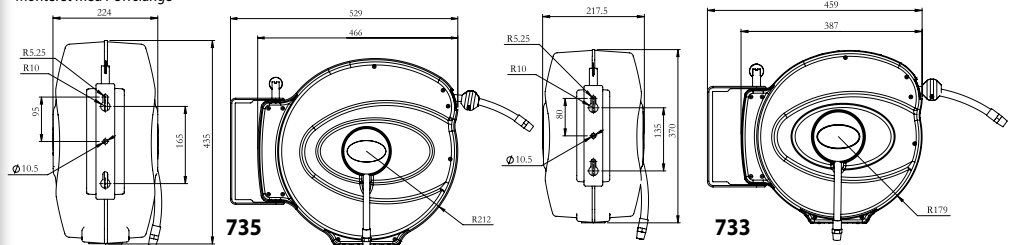

SERIE 730									
Dimension	Lgd. (m)	Slange	Medie	Max. tryk	Tilslutning	Afgang	Vægt	Best nr.	Pris
1/2"	15	PUR	luft	16 bar	udv. 1/2"	udv. 1/2"	8 kg	E737154	1.360,-
3/8"	20	PUR	luft	20 bar	udv. 3/8"	udv. 3/8"	8 kg	E737203	1.612,-

Teknisk beskrivelse
 * Boks i slagfast polypropylene med drejeligt væg-/loftbeslag
 * Låser automatisk slangen ved ønsket længde
 * Monteret med PUR slange

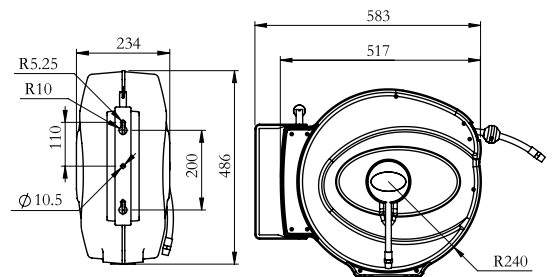

SERIE 701									
Dimension	Lgd. (m)	Slange	Medie	Max. tryk	Tilslutning	Afgang	Vægt	Best nr.	Pris
3/8"	15	gummi	luft/vand	20 bar	udv. 3/8"	udv. 3/8"	12,5 kg	E701153	1.738,-

Teknisk beskrivelse
 * Boks i slagfast polypropylene med drejeligt væg-/loftbeslag
 * Låser automatisk slangen ved ønsket længde
 * Monteret med SBR gummislange - max. temperatur 60°C

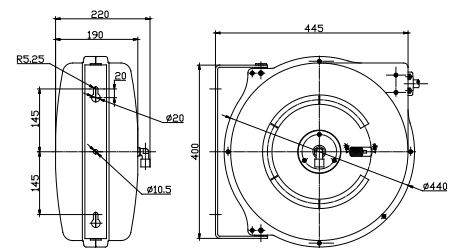

SERIE 170									
Dimension	Lgd. (m)	Slange	Medie	Max. tryk	Tilslutning	Afgang	Vægt	Best nr.	Pris
8/12mm	15	PUR	luft	12 bar	udv. 1/4"	udv. 1/4"	6 kg	171508	2.107,-

Teknisk beskrivelse
 * Boks i slagfast polypropylene med drejeligt væg-/loftbeslag
 * Låser automatisk slangen ved ønsket længde
 * Monteret med PUR slange

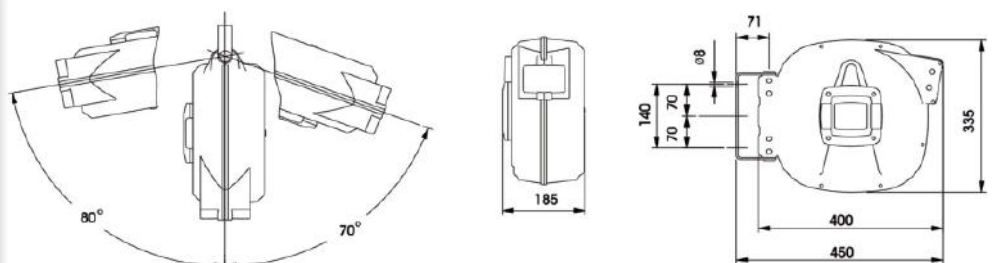



SERIE 827

Dimension	Lgd. (m)	Slange	Medie	Max. tryk	Tilslutning	Afgang	Vægt	Best nr.	Pris
3/8"	15	polymer	luft	20 bar	udv. 3/8"	udv. 3/8"	6 kg	E827153	1.195,-

Teknisk beskrivelse

- * Automatisk slangeopruller med eksklusiv "Soft Block" mekanisme som sikrer pålidelig og sikker tilbagerul.
- * Boks i slagfast polypropylene med drejeligt væg-/loftbeslag
- * Låser automatisk slangen ved ønsket længde
- * Monteret med polymer slange

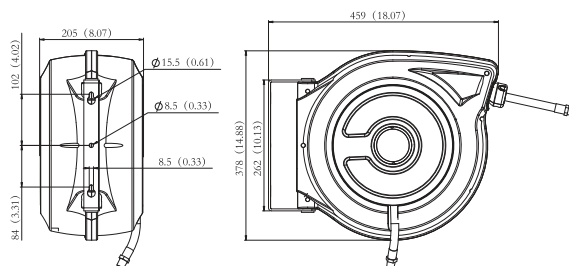

SERIE G701

Dimension	Lgd. (m)	Slange	Medie	Max. tryk	Tilslutning	Afgang	Vægt	Best nr.	Pris
1/2"	20	PVC	vand	10 bar	indv. 3/4"	kobling	10 kg	EG701204G	895,-
1/2"	30	PVC	vand	10 bar	indv. 3/4"	kobling	16 kg	EG760304G	1.632,-

Teknisk beskrivelse

- * Boks i slagfast polypropylene med drejeligt væg-/loftbeslag
- * Leveres med tilslutningslange, vandkobling og spulepistol

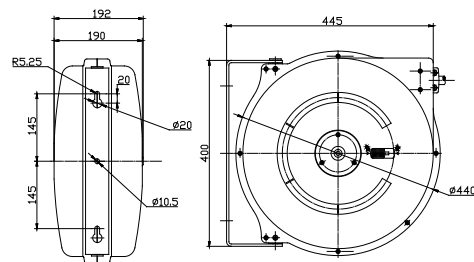

SERIE G770

Dimension	Lgd. (m)	Slange	Medie	Max. tryk	Tilslutning	Afgang	Vægt	Best nr.	Pris
1/2"	40	PVC	vand	8 bar	indv. 3/4"	kobling	14 kg	EG770404G	1.495,-

Teknisk beskrivelse

- * Boks i slagfast polypropylene med drejeligt væg-/loftbeslag
- * Leveres med tilslutningslange, vandkobling og strålespids

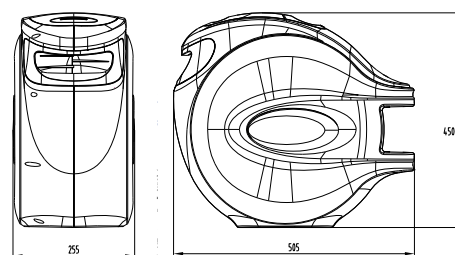

SERIE 8990

Dimension	Lgd. (m)	Slange	Medie	Max. tryk	Tilslutning	Afgang	Vægt	Best nr.	Pris
1/2"	20	PVC	vand	10 bar	indv. 3/4"	kobling	11,2 kg	89900000	1.446,-

Teknisk beskrivelse

- * Automatisk slangeopruller med eksklusiv "Soft Block" mekanisme som sikrer pålidelig og sikker tilbagerul.
- * 180° drejeligt vægbeslag.
- * Leveres med 2m tilslutningslange, 3/4" nippel, vandkobling og strålespids.



SERIE 301									
Dimension	Lgd. (m)	Slange	Medie	Max. tryk	Tilslutning	Afgang	Vægt	Best nr.	Pris
1/4"	60	u/slange	luft/vand	200 bar	indv. 1/4"	-	7 kg	EH301602	1.073,-
3/8"	30	u/slange	luft/vand	200 bar	indv. 3/8"	-	7 kg	EH301303	1.073,-

Teknisk beskrivelse

- * Kraftig pulverlakeret U-formet stålstel, justerbar tromlebremse og messingsvirvel
- * Montering på gulv, væg eller arbejdsbord, trinløs fjederlås, der forhindrer slangen i at løbe af tromlen
- * Leveres uden slange

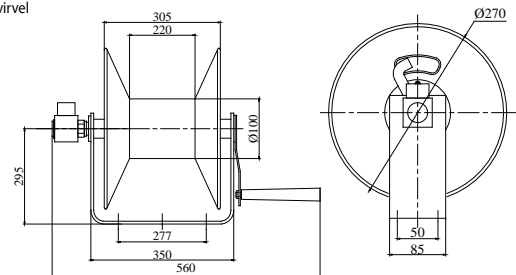

SERIE 420									
Dimension	Lgd. (m)	Slange	Medie	Max. tryk	Tilslutning	Afgang	Vægt	Best nr.	Pris
3/8"	90	u/slange	luft/vand	200 bar	indv. 3/8"	-	15 kg	EH420903	2.188,-
1/2"	45	u/slange	luft/vand	200 bar	indv. 1/2"	-	15 kg	EH420454	2.188,-

Teknisk beskrivelse

- * Kraftig pulverlakeret U-formet stålstel, justerbar tromlebremse og messingsvirvel
- * Montering på gulv, væg eller arbejdsbord, trinløs fjederlås, der forhindrer slangen i at løbe af tromlen
- * Leveres uden slange

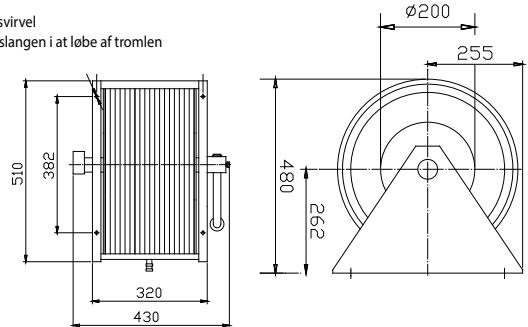

SERIE 491									
Dimension	Lgd. (m)	Slange	Medie	Max. tryk	Tilslutning	Afgang	Vægt	Best nr.	Pris
9,5/13mm	30	PUR	luft	16 bar	nippel	kobling	10 kg	491330	1.095,-

Teknisk beskrivelse

- * Håndbetjent slangeopruller til luft
- * Drejbar sokkel 360°
- * Kraftig pulverlakeret stålstel
- * Smidig PUR armeret slange

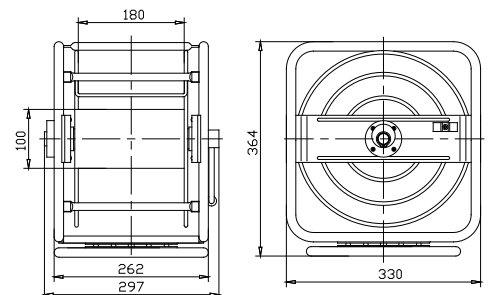

SERIE 493									
Dimension	Lgd. (m)	Slange	Medie	Max. tryk	Tilslutning	Afgang	Vægt	Best nr.	Pris
9,5/13mm	30	PUR	luft	16 bar	nippel	kobling	16 kg	493013	1.575,-

Teknisk beskrivelse

- * Automatisk slangeopruller til luft
- * Faste ben
- * Kraftig pulverlakeret stålstel
- * Smidig PUR armeret slange

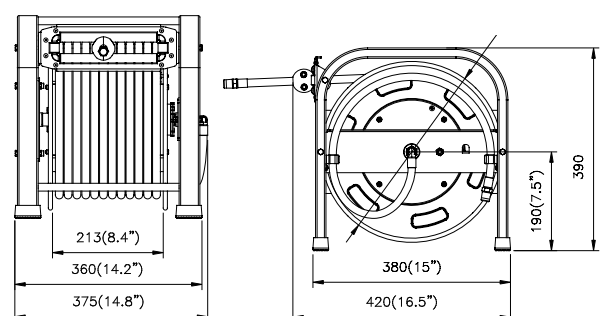



Til luft / koldt vand 20 bar

Til vand / varmt vand 130°C 200 / 400 bar

Til olie / kølevæske og beslægtede produkter 100 bar

Til fedt 400 bar

Til diesel / petroleum 10 bar

Til oxygen og acetylene 20 bar

LEVERINGSTID: På visse industri slangeoprullere må der påregnes en leveringstid på 4-5 uger fra ordremodtagelse.

Serie 440

Serie 260

Serie 280

Dimension	Lgd. (m)	Slange	Flow	Tilslutning	Afgang	Best nr.	Pris
-----------	----------	--------	------	-------------	--------	----------	------

SERIE 440 luft/koldt vand - 20 bar

u/slange	-	-	800 l/min	indv. 1/2"	indv. 1/2"	I440/10	2.885,-
1/2"	15	gummi	760 l/min	indv. 1/2"	udv. 1/2"	I440/11	4.521,-
3/8"	12	gummi	690 l/min	indv. 1/2"	udv. 3/8"	I440/12	4.066,-
3/8"	18	gummi	640 l/min	indv. 1/2"	udv. 3/8"	I440/13	4.449,-
1/2"	10	gummi	780 l/min	indv. 1/2"	udv. 1/2"	I440/14	4.019,-

Svirvel: Messing

Pakning: Viton

SERIE 440 olie/kølevæske og beslægtede produkter - 100 bar

u/slange	-	-	20 l/min	indv. 1/2"	indv. 1/2"	I440/40	2.951,-
1/2"	10	gummi	14 l/min	indv. 1/2"	udv. 1/2"	I440/41	4.138,-
1/2"	15	gummi	12 l/min	indv. 1/2"	udv. 1/2"	I440/42	4.687,-

Svirvel: Stål

Pakning: Polyurethane

SERIE 440 fedt - 400 bar

u/slange	-	-	1200 g/min	indv. 3/8"	indv. 1/2"	I440/50	2.906,-
1/4"	12	gummi	650 g/min	indv. 3/8"	udv. 1/4"	I440/51	4.168,-
1/4"	18	gummi	550 g/min	indv. 3/8"	udv. 1/4"	I440/52	4.663,-
3/8"	10	gummi	800 g/min	indv. 3/8"	udv. 1/4"	I440/55	4.400,-
3/8"	15	gummi	750 g/min	indv. 3/8"	udv. 1/4"	I440/56	4.949,-

Svirvel: Stål

Pakning: Polyurethane

SERIE 260 luft/koldt vand - 20 bar

8/12mm	11	PUR	350 l/min	udv. 1/4"	udv. 1/4"	I261/11	1.526,-
6/10mm	11	PUR	280 l/min	udv. 1/4"	udv. 1/4"	I261/12	1.447,-

Svirvel: Messing

Pakning: Viton

SERIE 280 luft/koldt vand - 20 bar / 40°C

8/12mm	10	PUR	-	udv. 3/8"	udv. 1/4"	I280103	1.953,-
8/12mm	14	PUR	-	udv. 3/8"	udv. 1/4"	I280143	2.058,-
10/14,5mm	8	PUR	-	udv. 3/8"	udv. 3/8"	I280083	1.979,-
10/14,5mm	12	PUR	-	udv. 3/8"	udv. 3/8"	I280123	2.148,-

Svirvel: Messing

Pakning: Viton



Monteringsplade se side 114



Dimension	Lgd. (m)	Slange	Flow	Tilslutning	Afgang	Best nr.	Pris
SERIE 270							
u/slange	-	-	800 l/min	udv. 3/8"	indv. 3/8"	I268/10	1.663,-
10/14,5mm	13 m	PUR	690 l/min	udv. 3/8"	udv. 3/8"	I268/12	2.493,-
8/12mm	15 m	PUR	320 l/min	udv. 3/8"	udv. 1/4"	I268/13	2.412,-
6/10mm	10 m	PUR	280 l/min	udv. 3/8"	udv. 1/4"	I268/14	2.235,-
6/10mm	15 m	PUR	250 l/min	udv. 3/8"	udv. 1/4"	I268/15	2.308,-
u/slange	-	-	800 l/min	udv. 3/8"	indv. 3/8"	I298/10	1.787,-
10/14,5mm	15 m	PUR	670 l/min	udv. 3/8"	udv. 3/8"	I298/12	2.707,-
8/12mm	18 m	PUR	300 l/min	udv. 3/8"	udv. 1/4"	I298/13	2.599,-
13/19mm	8 m	PUR	800 l/min	udv. 1/2"	udv. 1/2"	I298/14	2.856,-
13/19mm	12 m	PUR	780 l/min	udv. 1/2"	udv. 1/2"	I298/15	3.178,-
u/slange	-	-	800 l/min	udv. 3/8"	indv. 3/8"	I348/10	1.865,-
10/14,5mm	20 m	PUR	650 l/min	udv. 3/8"	udv. 3/8"	I348/12	3.048,-
8/12mm	20 m	PUR	280 l/min	udv. 3/8"	udv. 1/4"	I348/13	2.754,-
13/19mm	10 m	PUR	760 l/min	udv. 1/2"	udv. 1/2"	I348/14	3.089,-
13/19mm	15 m	PUR	760 l/min	udv. 1/2"	udv. 1/2"	I348/15	3.460,-
u/slange	-	-	800 l/min	indv. 1/2"	indv. 1/2"	I430/10	2.534,-
13/19mm	10 m	PUR	760 l/min	indv. 1/2"	udv. 1/2"	I428/11	3.750,-
13/19mm	15 m	PUR	740 l/min	indv. 1/2"	udv. 1/2"	I428/12	4.092,-

Svirvel: Messing

Pakning: Viton

Slange: Polyurethane



Monteringsplade + drejeligt vægbeslag se side 114-115



	Dimension	Lgd. (m)	Slange	Flow	Tilslutning	Afgang	Best nr.	Pris
SERIE 270								
	u/slange	-	-	800 l/min	indv. 3/8"	indv. 3/8"	I270/10	1.988,-
	3/8"	10	gummi	710 l/min	indv. 3/8"	udv. 3/8"	I270/11	3.058,-
SERIE 300								
	u/slange	-	-	800 l/min	indv. 3/8"	indv. 3/8"	I300/10	2.081,-
	3/8"	12	gummi	690 l/min	indv. 3/8"	udv. 3/8"	I300/11	3.238,-
SERIE 350								
	u/slange	-	-	800 l/min	indv. 3/8"	indv. 3/8"	I350/10	2.247,-
	3/8"	18	gummi	660 l/min	indv. 3/8"	udv. 3/8"	I350/11	3.888,-
	3/8"	12	gummi	690 l/min	indv. 3/8"	udv. 3/8"	I350/14	3.468,-
SERIE 430								
	u/slange	-	-	800 l/min	indv. 1/2"	indv. 1/2"	I430/10	2.534,-
	1/2"	15	gummi	760 l/min	indv. 1/2"	udv. 1/2"	I430/11	4.095,-
	3/8"	12	gummi	690 l/min	indv. 1/2"	udv. 3/8"	I430/12	3.637,-
	3/8"	18	gummi	660 l/min	indv. 1/2"	udv. 3/8"	I430/13	4.095,-
	1/2"	10	gummi	780 l/min	indv. 1/2"	udv. 1/2"	I430/14	3.667,-
SERIE 530								
	u/slange	-	-	800 l/min	indv. 1/2"	indv. 1/2"	I530/10	3.148,-
	1/2"	20	gummi	750 l/min	indv. 1/2"	udv. 1/2"	I530/11	5.198,-
	1/2"	25	gummi	740 l/min	indv. 1/2"	udv. 1/2"	I530/12	5.662,-
SERIE 540								
	u/slange	-	-	3000 l/min	indv. 1"	indv. 1"	I540/10	4.556,-
	3/4"	15	gummi	2800 l/min	indv. 1"	udv. 3/4"	I540/11	7.149,-
	3/4"	20	gummi	2750 l/min	indv. 1"	udv. 3/4"	I540/12	7.750,-
	1"	15	gummi	3000 l/min	indv. 1"	udv. 1"	I540/13	8.019,-
	u/slange	-	-	800 l/min	indv. 1/2"	indv. 1/2"	I540/15	4.233,-
	1/2"	30	gummi	720 l/min	indv. 1/2"	udv. 1/2"	I540/16	7.393,-
SERIE 560								
	u/slange	-	-	3000 l/min	indv. 1"	indv. 1"	I560/10	8.169,-
	3/4"	30	gummi	2700 l/min	indv. 1"	udv. 3/4"	I560/11	12.580,-
	3/4"	35	gummi	2650 l/min	indv. 1"	udv. 3/4"	I560/12	13.217,-
	3/4"	40	gummi	2600 l/min	indv. 1"	udv. 3/4"	I560/13	13.892,-
	1"	20	gummi	2950 l/min	indv. 1"	udv. 1"	I560/14	12.305,-
	1"	30	gummi	2900 l/min	indv. 1"	udv. 1"	I560/15	13.912,-
	u/slange	-	-	800 l/min	indv. 1/2"	indv. 1/2"	I560/16	7.542,-
	1/2"	40	gummi	700 l/min	indv. 1/2"	udv. 1/2"	I560/17	11.035,-
	1/2"	50	gummi	680 l/min	indv. 1/2"	udv. 1/2"	I560/18	11.905,-
	1/2"	60	gummi	660 l/min	indv. 1/2"	udv. 1/2"	I560/19	12.657,-

Svirvel: Messing

Pakning: Viton



Monteringsplade + drejeligt vægbeslag se side 114-115



Dimension	Lgd. (m)	Slange	Flow	Tilslutning	Afgang	Best nr.	Pris
SERIE 270							
u/slange	-	-	800 l/min	indv. 3/8"	indv. 3/8"	I272/10	3.055,-
3/8"	10	gummi	710 l/min	indv. 3/8"	udv. 3/8"	I272/11	4.108,-
SERIE 300							
u/slange	-	-	800 l/min	indv. 3/8"	indv. 3/8"	I302/10	3.149,-
3/8"	12	gummi	690 l/min	indv. 3/8"	udv. 3/8"	I302/11	4.275,-
SERIE 350							
u/slange	-	-	800 l/min	indv. 3/8"	indv. 3/8"	I352/10	3.423,-
3/8"	18	gummi	660 l/min	indv. 3/8"	udv. 3/8"	I352/11	4.949,-
3/8"	12	gummi	690 l/min	indv. 3/8"	udv. 3/8"	I352/14	4.649,-
SERIE 430							
u/slange	-	-	800 l/min	indv. 1/2"	indv. 1/2"	I432/10	4.674,-
1/2"	15	gummi	760 l/min	indv. 1/2"	udv. 1/2"	I432/11	6.182,-
3/8"	12	gummi	690 l/min	indv. 1/2"	udv. 3/8"	I432/12	5.866,-
3/8"	18	gummi	660 l/min	indv. 1/2"	udv. 3/8"	I432/13	6.182,-
1/2"	10	gummi	780 l/min	indv. 1/2"	udv. 1/2"	I432/14	5.885,-
SERIE 530							
u/slange	-	-	800 l/min	indv. 1/2"	indv. 1/2"	I532/10	5.754,-
1/2"	20	gummi	750 l/min	indv. 1/2"	udv. 1/2"	I532/11	7.787,-
1/2"	25	gummi	740 l/min	indv. 1/2"	udv. 1/2"	I532/12	8.264,-
SERIE 540							
u/slange	-	-	3000 l/min	indv. 1"	indv. 1"	I542/10	7.214,-
3/4"	15	gummi	2800 l/min	indv. 1"	udv. 3/4"	I542/11	9.891,-
3/4"	20	gummi	2750 l/min	indv. 1"	udv. 3/4"	I542/12	10.654,-
1"	15	gummi	3000 l/min	indv. 1"	udv. 1"	I542/13	10.761,-
u/slange	-	-	800 l/min	indv. 1/2"	indv. 1/2"	I542/15	7.357,-
1/2"	30	gummi	720 l/min	indv. 1/2"	udv. 1/2"	I542/16	9.605,-
SERIE 560							
u/slange	-	-	3000 l/min	indv. 1"	indv. 1"	I562/10	13.068,-
3/4"	30	gummi	2700 l/min	indv. 1"	udv. 3/4"	I562/11	17.755,-
3/4"	35	gummi	2650 l/min	indv. 1"	udv. 3/4"	I562/12	18.425,-
3/4"	40	gummi	2600 l/min	indv. 1"	udv. 3/4"	I562/13	19.063,-
1"	20	gummi	2950 l/min	indv. 1"	udv. 1"	I562/14	17.475,-
1"	30	gummi	2900 l/min	indv. 1"	udv. 1"	I562/15	19.144,-
u/slange	-	-	800 l/min	indv. 1/2"	indv. 1/2"	I562/16	12.317,-
1/2"	40	gummi	700 l/min	indv. 1/2"	udv. 1/2"	I562/17	16.067,-
1/2"	50	gummi	680 l/min	indv. 1/2"	udv. 1/2"	I562/18	16.955,-
1/2"	60	gummi	660 l/min	indv. 1/2"	udv. 1/2"	I562/19	17.725,-

Svirvel: Messing

Pakning: Viton



Monteringsplade + drejeligt vægbeslag se side 114-115



	Dimension	Lgd. (m)	Slange	Flow	Tilslutning	Afgang	Best nr.	Pris
SERIE 300								
	u/slange	-	-	800 l/min	indv. 3/8"	indv. 3/8"	I302/10	3.149,-
	3/8"	12	hygiejnisk	690 l/min	indv. 3/8"	udv. 3/8"	I303/11	4.775,-
SERIE 430								
	u/slange	-	-	800 l/min	indv. 1/2"	indv. 1/2"	I432/10	4.675,-
	1/2"	10	hygiejnisk	760 l/min	indv. 1/2"	udv. 1/2"	I433/11	6.182,-
	1/2"	15	hygiejnisk	690 l/min	indv. 1/2"	udv. 1/2"	I433/12	6.309,-
SERIE 530								
	u/slange	-	-	800 l/min	indv. 1/2"	indv. 1/2"	I532/10	5.754,-
	1/2"	20	hygiejnisk	750 l/min	indv. 1/2"	udv. 1/2"	I533/11	8.358,-
	1/2"	25	hygiejnisk	740 l/min	indv. 1/2"	udv. 1/2"	I533/12	8.871,-
SERIE 540								
	u/slange	-	-	3000 l/min	indv. 1"	indv. 1"	I542/10	7.214,-
	3/4"	15	hygiejnisk	2800 l/min	indv. 1"	udv. 3/4"	I543/11	10.791,-
	3/4"	20	hygiejnisk	2750 l/min	indv. 1"	udv. 3/4"	I543/12	11.800,-
	1"	15	hygiejnisk	3000 l/min	indv. 1"	udv. 1"	I543/13	12.198,-
	u/slange	-	-	800 l/min	indv. 1/2"	indv. 1/2"	I542/15	7.357,-
	1/2"	30	hygiejnisk	720 l/min	indv. 1/2"	udv. 1/2"	I543/16	10.457,-
SERIE 560								
	u/slange	-	-	3000 l/min	indv. 1"	indv. 1"	I562/10	13.068,-
	3/4"	30	hygiejnisk	2700 l/min	indv. 1"	udv. 3/4"	I563/11	18.882,-
	3/4"	40	hygiejnisk	2600 l/min	indv. 1"	udv. 3/4"	I563/13	20.747,-
	1"	20	hygiejnisk	2950 l/min	indv. 1"	udv. 1"	I563/14	18.820,-
	1"	30	hygiejnisk	2900 l/min	indv. 1"	udv. 1"	I563/15	21.471,-

Svirvel: Messing

Pakning: Viton



Monteringsplade + drejeligt vægbeslag se side 114-115



Dimension	Lgd. (m)	Slange	Flow	Tilslutning	Afgang	Best nr.	Pris
SERIE 300							
u/slange	-	-	800 l/min	udv. 3/8" v. gevind	udv. 3/8" v. gevind	I300/80	2.261,-
8/15mm	8	NBR/PVC	400 l/min	indv. 3/8" v. gevind	indv. 3/8" v. gevind	I300/81	3.127,-
10/17mm	10	NBR/PVC	720 l/min	indv. 3/8" v. gevind	indv. 3/8" v. gevind	I300/82	3.158,-
SERIE 350							
u/slange	-	-	800 l/min	udv. 3/8" v. gevind	udv. 3/8" v. gevind	I350/80	2.650,-
8/15mm	15	NBR/PVC	350 l/min	indv. 3/8" v. gevind	indv. 3/8" v. gevind	I350/81	3.861,-
10/17mm	15	NBR/PVC	700 l/min	indv. 3/8" v. gevind	indv. 3/8" v. gevind	I350/82	4.115,-
SERIE 430							
u/slange	-	-	800 l/min	udv. 3/8" v. gevind	udv. 3/8" v. gevind	I430/80	3.010,-
8/15mm	15	NBR/PVC	350 l/min	indv. 3/8" v. gevind	indv. 3/8" v. gevind	I430/81	4.894,-
8/15mm	20	NBR/PVC	320 l/min	indv. 3/8" v. gevind	indv. 3/8" v. gevind	I430/82	4.948,-
10/17mm	12	NBR/PVC	700 l/min	indv. 3/8" v. gevind	indv. 3/8" v. gevind	I430/83	4.230,-
10/17mm	18	NBR/PVC	680 l/min	indv. 3/8" v. gevind	indv. 3/8" v. gevind	I430/84	4.693,-
SERIE 530							
u/slange	-	-	800 l/min	udv. 3/8" v. gevind	udv. 3/8" v. gevind	I530/80	4.027,-
8/15mm	28	NBR/PVC	270 l/min	indv. 3/8" v. gevind	indv. 3/8" v. gevind	I530/82	6.032,-
10/17mm	27	NBR/PVC	630 l/min	indv. 3/8" v. gevind	indv. 3/8" v. gevind	I530/84	6.205,-
SERIE 540							
u/slange	-	-	800 l/min	udv. 3/8" v. gevind	udv. 3/8" v. gevind	I540/80	4.993,-
10/17mm	30	NBR/PVC	620 l/min	indv. 3/8" v. gevind	indv. 3/8" v. gevind	I540/82	7.149,-

Svirvel: Messing

Pakning: Viton



Monteringsplade + drejeligt vægbeslag se side 114-115



	Dimension	Lgd. (m)	Slange	Flow	Tilslutning	Afgang	Best nr.	Pris
SERIE 300								
	u/slange	-	-	30 l/min	indv. 3/8"	indv. 3/8"	I300/30	2.528,-
	5/16"	12	gummi	25 l/min	indv. 3/8"	indv. 3/8"	I300/31	3.667,-
SERIE 350								
	u/slange	-	-	30 l/min	indv. 3/8"	indv. 3/8"	I350/30	3.542,-
	5/16"	12	gummi	25 l/min	indv. 3/8"	indv. 3/8"	I350/31	3.969,-
	5/16"	17	gummi	24 l/min	indv. 3/8"	indv. 3/8"	I350/32	4.490,-
SERIE 430								
	u/slange	-	-	30 l/min	indv. 3/8"	indv. 1/2"	I430/30	2.778,-
	3/8"	12	gummi	27 l/min	indv. 3/8"	indv. 3/8"	I430/31	4.168,-
	3/8"	18	gummi	25 l/min	indv. 3/8"	indv. 3/8"	I430/32	4.782,-
SERIE 530								
	u/slange	-	-	30 l/min	indv. 3/8"	indv. 1/2"	I530/30	3.542,-
	3/8"	25	gummi	24 l/min	indv. 3/8"	indv. 3/8"	I530/31	6.248,-
	3/8"	20	gummi	25 l/min	indv. 3/8"	indv. 3/8"	I530/32	5.741,-
SERIE 540								
	u/slange	-	-	30 l/min	indv. 3/8"	indv. 1/2"	I540/30	4.459,-
	3/8"	30	gummi	22 l/min	indv. 3/8"	indv. 3/8"	I540/31	7.644,-
SERIE 560								
	u/slange	-	-	30 l/min	indv. 3/8"	indv. 1/2"	I560/30	8.048,-
	3/8"	40	gummi	20 l/min	indv. 3/8"	indv. 3/8"	I560/31	12.212,-
	3/8"	50	gummi	18 l/min	indv. 3/8"	indv. 3/8"	I560/32	13.110,-

Svirvel: Rustfri AISI 304

Pakning: Viton

Slange: Kan også leveres med afsmitningsfri hygiejnisk slange



Monteringsplade + drejeligt vægbeslag se side 114-115



	Dimension	Lgd. (m)	Slange	Flow	Tilslutning	Afgang	Best nr.	Pris
SERIE 300								
	u/slange	-	-	30 l/min	indv. 3/8"	indv. 3/8"	I302/30	3.477,-
	5/16"	12	gummi	25 l/min	indv. 3/8"	indv. 3/8"	I302/31	4.518,-
SERIE 350								
	u/slange	-	-	30 l/min	indv. 3/8"	indv. 3/8"	I352/30	3.824,-
	5/16"	12	gummi	25 l/min	indv. 3/8"	indv. 3/8"	I352/31	4.960,-
	5/16"	17	gummi	24 l/min	indv. 3/8"	indv. 3/8"	I352/32	5.473,-
SERIE 430								
	u/slange	-	-	30 l/min	indv. 3/8"	indv. 1/2"	I434/30	5.068,-
	3/8"	12	gummi	27 l/min	indv. 3/8"	indv. 3/8"	I432/31	6.430,-
	3/8"	18	gummi	25 l/min	indv. 3/8"	indv. 3/8"	I432/32	7.047,-
SERIE 530								
	u/slange	-	-	30 l/min	indv. 3/8"	indv. 1/2"	I534/30	7.071,-
	3/8"	20	gummi	24 l/min	indv. 3/8"	indv. 3/8"	I532/32	9.194,-
	3/8"	25	gummi	25 l/min	indv. 3/8"	indv. 3/8"	I532/31	9.694,-
SERIE 540								
	u/slange	-	-	30 l/min	indv. 3/8"	indv. 1/2"	I544/30	7.345,-
	3/8"	30	gummi	22 l/min	indv. 3/8"	indv. 3/8"	I542/31	10.464,-
SERIE 560								
	u/slange	-	-	30 l/min	indv. 3/8"	indv. 1/2"	I564/30	12.943,-
	3/8"	40	gummi	20 l/min	indv. 3/8"	indv. 3/8"	I562/31	16.992,-
	3/8"	50	gummi	18 l/min	indv. 3/8"	indv. 3/8"	I562/32	17.903,-

Svirvel: Rustfri AISI 304

Pakning: Viton

Slange: Kan også leveres med afsmitningsfri hygiejnisk slange



Monteringsplade + drejeligt vægbeslag se side 114-115



	Dimension	Lgd. (m)	Slange	Flow	Tilslutning	Afgang	Best nr.	Pris
SERIE 300								
	u/slange	-	-	40 l/min	indv. 3/8"	indv. 3/8"	I300/35	2.933,-
	5/16"	12	gummi	38 l/min	indv. 3/8"	indv. 3/8"	I300/36	4.383,-
SERIE 350								
	u/slange	-	-	40 l/min	indv. 3/8"	indv. 3/8"	I350/35	3.178,-
	5/16"	12	gummi	38 l/min	indv. 3/8"	indv. 3/8"	I350/36	4.626,-
	5/16"	17	gummi	35 l/min	indv. 3/8"	indv. 3/8"	I350/37	5.176,-
SERIE 430								
	u/slange	-	-	40 l/min	indv. 3/8"	indv. 1/2"	I430/35	3.012,-
	3/8"	12	gummi	40 l/min	indv. 3/8"	indv. 3/8"	I430/36	4.817,-
	3/8"	15	gummi	38 l/min	indv. 3/8"	indv. 3/8"	I430/39	5.622,-
SERIE 530								
	u/slange	-	-	40 l/min	indv. 3/8"	indv. 1/2"	I530/35	3.785,-
	3/8"	20	gummi	38 l/min	indv. 3/8"	indv. 3/8"	I530/36	6.624,-
	3/8"	25	gummi	35 l/min	indv. 3/8"	indv. 3/8"	I530/37	7.239,-
SERIE 540								
	u/slange	-	-	40 l/min	indv. 3/8"	indv. 1/2"	I540/35	4.746,-
	3/8"	30	gummi	33 l/min	indv. 3/8"	indv. 3/8"	I540/36	8.717,-
SERIE 560								
	u/slange	-	-	40 l/min	indv. 3/8"	indv. 1/2"	I560/35	8.407,-
	3/8"	40	gummi	30 l/min	indv. 3/8"	indv. 3/8"	I560/36	13.462,-
	3/8"	50	gummi	28 l/min	indv. 3/8"	indv. 3/8"	I560/37	14.726,-

Svirvel: Rustfri AISI 304

Pakning: Teflon

Slange: Kan også leveres med afsmitningsfri hygiejnisk slange



Monteringsplade + drejeligt vægbeslag se side 114-115



	Dimension	Lgd. (m)	Slange	Flow	Tilslutning	Afgang	Best nr.	Pris
SERIE 300								
	u/slange	-	-	40 l/min	indv. 3/8"	indv. 3/8"	I302/35	3.892,-
	5/16"	12	gummi	38 l/min	indv. 3/8"	indv. 3/8"	I302/36	5.348,-
SERIE 350								
	u/slange	-	-	40 l/min	indv. 3/8"	indv. 3/8"	I352/35	4.401,-
	5/16"	12	gummi	38 l/min	indv. 3/8"	indv. 3/8"	I352/36	5.832,-
	5/16"	17	gummi	35 l/min	indv. 3/8"	indv. 3/8"	I352/37	6.385,-
SERIE 430								
	u/slange	-	-	40 l/min	indv. 3/8"	indv. 1/2"	I434/35	5.392,-
	3/8"	12	gummi	40 l/min	indv. 3/8"	indv. 3/8"	I432/36	7.191,-
	3/8"	15	gummi	38 l/min	indv. 3/8"	indv. 3/8"	I432/39	7.984,-
SERIE 530								
	u/slange	-	-	40 l/min	indv. 3/8"	indv. 1/2"	I534/35	7.287,-
	3/8"	20	gummi	38 l/min	indv. 3/8"	indv. 3/8"	I532/36	10.124,-
	3/8"	25	gummi	35 l/min	indv. 3/8"	indv. 3/8"	I532/37	10.733,-
SERIE 540								
	u/slange	-	-	40 l/min	indv. 3/8"	indv. 1/2"	I544/35	7.572,-
	3/8"	30	gummi	33 l/min	indv. 3/8"	indv. 3/8"	I542/36	11.494,-
SERIE 560								
	u/slange	-	-	40 l/min	indv. 3/8"	indv. 1/2"	I564/35	13.235,-
	3/8"	40	gummi	30 l/min	indv. 3/8"	indv. 3/8"	I562/36	18.256,-
	3/8"	50	gummi	28 l/min	indv. 3/8"	indv. 3/8"	I562/37	19.478,-

Svirvel: Rustfri AISI 304

Pakning: Teflon

Slange: Kan også leveres med afsmitningsfri hygiejnisk slange



Monteringsplade + drejeligt vægbeslag se side 114-115



	Dimension	Lgd. (m)	Slange	Flow	Tilslutning	Afgang	Best nr.	Pris
SERIE 300								
	u/slange	-	-	18 l/min	indv. 1/2"	F 3/8" - indv. 1/2"	I300/40	2.247,-
	1/2"	8	gummi	13 l/min	indv. 1/2"	udv. 1/2"	I300/41	3.231,-
	3/8"	12	gummi	11 l/min	indv. 1/2"	udv. 1/2"	I300/42	3.571,-
SERIE 350								
	u/slange	-	-	18 l/min	indv. 1/2"	F 3/8" - indv. 1/2"	I350/40	2.402,-
	1/2"	10	gummi	12 l/min	indv. 1/2"	udv. 1/2"	I350/41	3.529,-
	3/8"	17	gummi	9 l/min	indv. 1/2"	udv. 1/2"	I350/42	4.138,-
SERIE 430								
	u/slange	-	-	20 l/min	indv. 1/2"	indv. 1/2"	I430/40	2.719,-
	1/2"	10	gummi	14 l/min	indv. 1/2"	udv. 1/2"	I430/41	3.911,-
	1/2"	15	gummi	12 l/min	indv. 1/2"	udv. 1/2"	I430/42	4.459,-
SERIE 530								
	u/slange	-	-	20 l/min	indv. 1/2"	indv. 1/2"	I530/40	3.435,-
	1/2"	20	gummi	10 l/min	indv. 1/2"	udv. 1/2"	I530/41	5.479,-
	1/2"	25	gummi	9 l/min	indv. 1/2"	udv. 1/2"	I530/42	5.966,-
SERIE 540								
	u/slange	-	-	40 l/min	indv. 1"	indv. 1"	I540/40	4.603,-
	1"	15	gummi	35 l/min	indv. 1"	udv. 1"	I540/41	8.400,-
	3/4"	20	gummi	26 l/min	indv. 1"	udv. 3/4"	I540/43	8.136,-
	u/slange	-	-	20 l/min	indv. 1/2"	indv. 1/2"	I540/45	4.305,-
	1/2"	30	-	8 l/min	indv. 1/2"	indv. 1/2"	I540/46	7.524,-
SERIE 560								
	u/slange	-	-	40 l/min	indv. 1"	indv. 1"	I560/40	8.145,-
	3/4"	30	gummi	22 l/min	indv. 1"	udv. 3/4"	I560/41	12.699,-
	3/4"	35	gummi	20 l/min	indv. 1"	udv. 3/4"	I560/42	12.344,-
	3/4"	40	gummi	18 l/min	indv. 1"	udv. 3/4"	I560/43	14.016,-
	1"	20	gummi	32 l/min	indv. 1"	indv. 1"	I560/44	12.914,-
	1"	30	gummi	30 l/min	indv. 1"	indv. 1"	I560/45	14.928,-
	u/slange	-	-	20 l/min	indv. 1/2"	indv. 1/2"	I560/46	7.721,-
	1/2"	40	gummi	7 l/min	indv. 1/2"	udv. 1/2"	I560/47	11.937,-
	1/2"	50	gummi	6 l/min	indv. 1/2"	udv. 1/2"	I560/48	12.902,-
	1/2"	60	gummi	5 l/min	indv. 1/2"	udv. 1/2"	I560/49	13.926,-

Svirvel: Stål

Pakning: Polyurethane



Monteringsplade + drejeligt vægbeslag se side 114-115



Dimension	Lgd. (m)	Slange	Flow	Tilslutning	Afgang	Best nr.	Pris
SERIE 300							
u/slange	-	-	18 l/min	indv. 1/2"	F 3/8" - indv. 1/2"	I302/40	3.715,-
1/2"	8	gummi	13 l/min	indv. 1/2"	udv. 1/2"	I302/41	4.753,-
3/8"	12	gummi	11 l/min	indv. 1/2"	udv. 1/2"	I302/42	4.997,-
SERIE 350							
u/slange	-	-	18 l/min	indv. 1/2"	F 3/8" - indv. 1/2"	I352/40	3.805,-
1/2"	10	gummi	12 l/min	indv. 1/2"	udv. 1/2"	I352/41	4.919,-
3/8"	17	gummi	9 l/min	indv. 1/2"	udv. 1/2"	I352/42	5.515,-
SERIE 430							
u/slange	-	-	20 l/min	indv. 1/2"	indv. 1/2"	I434/20	5.052,-
1/2"	10	gummi	14 l/min	indv. 1/2"	udv. 1/2"	I432/41	6.141,-
1/2"	15	gummi	12 l/min	indv. 1/2"	udv. 1/2"	I432/42	6.691,-
SERIE 530							
u/slange	-	-	20 l/min	indv. 1/2"	indv. 1/2"	I534/20	7.030,-
1/2"	20	gummi	10 l/min	indv. 1/2"	udv. 1/2"	I532/41	9.146,-
1/2"	25	gummi	9 l/min	indv. 1/2"	udv. 1/2"	I532/42	9.635,-
SERIE 540							
u/slange	-	-	40 l/min	indv. 1"	indv. 1"	I544/20	7.834,-
1"	15	gummi	35 l/min	indv. 1"	udv. 1"	I542/41	11.572,-
3/4"	15	gummi	30 l/min	indv. 1"	udv. 3/4"	I542/42	10.379,-
3/4"	20	gummi	26 l/min	indv. 1"	udv. 3/4"	I542/43	11.083,-
u/slange	-	-	20 l/min	indv. 1/2"	indv. 1/2"	I544/25	7.435,-
1/2"	30	-	8 l/min	indv. 1/2"	indv. 1/2"	I542/46	10.474,-

Svirvel: Rustfri AISI 304

Pakning: Viton



Monteringsplade + drejeligt vægbeslag se side 114-115



Dimension	Lgd. (m)	Slange	Flow	Tilslutning	Afgang	Best nr.	Pris
SERIE 300							
u/slange	-	-	1200 g/min	indv. 3/8"	indv. 3/8"	I300/50	2.294,-
1/4"	12	gummi	650 g/min	indv. 3/8"	udv. 1/4"	I300/51	3.542,-
SERIE 350							
u/slange	-	-	1200 g/min	indv. 3/8"	indv. 3/8"	I350/50	2.308,-
1/4"	12	gummi	650 g/min	indv. 3/8"	udv. 1/4"	I350/51	3.560,-
1/4"	16	gummi	550 g/min	indv. 3/8"	udv. 1/4"	I350/52	3.864,-
SERIE 430							
u/slange	-	-	1200 g/min	indv. 3/8"	indv. 1/2"	I430/50	2.814,-
1/4"	12	gummi	650 g/min	indv. 3/8"	udv. 1/4"	I430/51	3.989,-
1/4"	18	gummi	550 g/min	indv. 3/8"	udv. 1/4"	I430/52	4.483,-
3/8"	10	gummi	800 g/min	indv. 3/8"	udv. 1/4"	I430/55	4.216,-
3/8"	15	gummi	750 g/min	indv. 3/8"	udv. 1/4"	I430/56	4.764,-
SERIE 530							
u/slange	-	-	1200 g/min	indv. 3/8"	indv. 1/2"	I530/50	3.620,-
3/8"	20	gummi	600 g/min	indv. 3/8"	udv. 1/4"	I530/51	6.309,-
3/8"	25	gummi	500 g/min	indv. 3/8"	udv. 1/4"	I530/52	6.796,-
SERIE 540							
u/slange	-	-	1200 g/min	indv. 3/8"	indv. 1/2"	I540/50	4.340,-
3/8"	30	gummi	450 g/min	indv. 3/8"	udv. 1/4"	I540/51	8.121,-

Svirvel: Stål

Pakning: Polyurethane



Monteringsplade + drejeligt vægbeslag se side 114-115



Dimension	Lgd. (m)	Slange	Flow	Tilslutning	Afgang	Best nr.	Pris
SERIE 300							
u/slange	-	-	1200 g/min	indv. 3/8"	indv. 3/8"	I302/50	3.149,-
1/4"	12	gummi	650 g/min	indv. 3/8"	udv. 1/4"	I302/51	4.369,-
SERIE 350							
u/slange	-	-	1200 g/min	indv. 3/8"	indv. 3/8"	I352/50	3.607,-
1/4"	12	gummi	650 g/min	indv. 3/8"	udv. 1/4"	I352/51	4.822,-
1/4"	16	gummi	550 g/min	indv. 3/8"	udv. 1/4"	I352/52	5.161,-
SERIE 430							
u/slange	-	-	1200 g/min	indv. 3/8"	indv. 1/2"	I432/50	4.686,-
1/4"	12	gummi	650 g/min	indv. 3/8"	udv. 1/4"	I432/51	5.862,-
1/4"	18	gummi	550 g/min	indv. 3/8"	udv. 1/4"	I432/52	6.319,-
3/8"	10	gummi	800 g/min	indv. 3/8"	udv. 1/4"	I432/55	6.064,-
3/8"	15	gummi	750 g/min	indv. 3/8"	udv. 1/4"	I432/56	6.612,-
SERIE 530							
u/slange	-	-	1200 g/min	indv. 3/8"	indv. 1/2"	I532/50	6.261,-
3/8"	20	gummi	600 g/min	indv. 3/8"	udv. 1/4"	I532/51	8.949,-
3/8"	25	gummi	500 g/min	indv. 3/8"	udv. 1/4"	I532/52	9.449,-
SERIE 540							
u/slange	-	-	1200 g/min	indv. 3/8"	indv. 1/2"	I542/50	6.964,-
3/8"	30	gummi	450 g/min	indv. 3/8"	udv. 1/4"	I542/51	10.689,-

Svirvel: Stål

Pakning: Polyurethane



Monteringsplade + drejeligt vægbeslag se side 114-115



Dimension	Lgd. (m)	Slange	Flow	Tilslutning	Afgang	Best nr.	Pris
SERIE 530							
u/slange	-	-	50 l/min	indv. 1/2"	indv. 1/2"	I530/10	3.148,-
u/slange	-	-	100 l/min	indv. 1"	indv. 1"	I530/60	4.155,-
19/27mm	12	gummi	87 l/min	indv. 1"	udv. 3/4"	I530/63	5.913,-
25/35mm	8	gummi	93 l/min	indv. 1"	udv. 1"	I530/64	6.152,-
SERIE 540							
u/slange	-	-	100 l/min	indv. 1"	indv. 1"	I540/10	4.556,-
19/27mm	15	gummi	85 l/min	indv. 1"	udv. 3/4"	I540/61	6.523,-
19/27mm	20	gummi	83 l/min	indv. 1"	udv. 3/4"	I540/62	7.234,-
25/35mm	15	gummi	90 l/min	indv. 1"	udv. 1"	I540/63	7.668,-
SERIE 560							
u/slange	-	-	100 l/min	indv. 1"	indv. 1"	I560/10	8.196,-
19/27mm	40	gummi	76 l/min	indv. 1"	udv. 3/4"	I560/63	12.532,-
25/35mm	20	gummi	87 l/min	indv. 1"	udv. 1"	I560/64	11.246,-
25/35mm	30	gummi	85 l/min	indv. 1"	udv. 1"	I560/65	14.058,-

Svirvel: Messing

Pakning: Viton

Slange: Antistatisk gummi



Monteringsplade + drejeligt vægbeslag se side 114-115



Dimension	Lgd. (m)	Slange	Flow	Tilslutning	Afgang	Best nr.	Pris
SERIE 540							
u/slange	-	-	100 l/min	indv. 1"	indv. 1"	I542/10	7.214,-
19/27mm	15	gummi	85 l/min	indv. 1"	udv. 3/4"	I542/61	9.265,-
19/27mm	20	gummi	83 l/min	indv. 1"	udv. 3/4"	I542/62	9.790,-
25/35mm	15	gummi	90 l/min	indv. 1"	udv. 1"	I542/63	10.427,-
SERIE 560							
u/slange	-	-	100 l/min	indv. 1"	indv. 1"	I562/10	13.068,-
19/27mm	40	gummi	76 l/min	indv. 1"	udv. 3/4"	I562/63	17.326,-
25/35mm	20	gummi	87 l/min	indv. 1"	udv. 1"	I562/64	17.051,-
25/35mm	30	gummi	85 l/min	indv. 1"	udv. 1"	I562/65	18.852,-

Svirvel: Messing

Pakning: Viton

Slange: Antistatisk gummi



Monteringsplade + drejeligt vægbeslag se side 114-115



Dimension	Lgd. (m)	Slange	Flow	Tilslutning	Afgang	Best nr.	Pris
SERIE 430							
u/slange	-	-	800 l/min	udv. 3/8"	udv. 3/8"	I430/70	3.207,-
2x1/4"	13	SBR/EPDM	250 l/min	indv. 3/8"	indv. 3/8"	I430/71	4.614,-
2x5/16"	12	SBR/EPDM	360 l/min	indv. 3/8"	indv. 3/8"	I430/72	4.614,-
SERIE 530							
u/slange	-	-	800 l/min	udv. 3/8"	udv. 3/8"	I530/70	4.174,-
2x1/4"	17	SBR/EPDM	220 l/min	indv. 3/8"	indv. 3/8"	I530/71	5.818,-
2x1/4"	20	SBR/EPDM	200 l/min	indv. 3/8"	indv. 3/8"	I530/72	6.021,-
2x5/16"	15	SBR/EPDM	300 l/min	indv. 3/8"	indv. 3/8"	I530/73	5.771,-
2x5/16"	20	SBR/EPDM	290 l/min	indv. 3/8"	indv. 3/8"	I530/74	6.160,-
2x3/8"	15	SBR/EPDM	660 l/min	indv. 3/8"	indv. 3/8"	I530/75	5.832,-
SERIE 540							
u/slange	-	-	800 l/min	udv. 3/8"	udv. 3/8"	I540/70	5.116,-
2x1/4"	25	SBR/EPDM	180 l/min	indv. 3/8"	indv. 3/8"	I540/71	7.280,-
2x1/4"	30	SBR/EPDM	160 l/min	indv. 3/8"	indv. 3/8"	I540/72	7.650,-
2x1/4"	35	SBR/EPDM	140 l/min	indv. 3/8"	indv. 3/8"	I540/73	7.971,-
2x5/16"	25	SBR/EPDM	270 l/min	indv. 3/8"	indv. 3/8"	I540/74	7.435,-
2x5/16"	30	SBR/EPDM	250 l/min	indv. 3/8"	indv. 3/8"	I540/75	7.830,-
2x5/16"	35	SBR/EPDM	230 l/min	indv. 3/8"	indv. 3/8"	I540/76	8.184,-
2x3/8"	20	SBR/EPDM	640 l/min	indv. 3/8"	indv. 3/8"	I540/77	7.178,-
2x3/8"	25	SBR/EPDM	600 l/min	indv. 3/8"	indv. 3/8"	I540/78	7.572,-
2x3/8"	27	SBR/EPDM	570 l/min	indv. 3/8"	indv. 3/8"	I540/79	7.834,-

Svirvel: Messing

Pakning: Viton



Monteringsplade + drejeligt vægbeslag se side 114-115

**PULVER-
LAKERET**

**AISI 304
RUSTFRI
STÅL**



Note: Alle oprullere leveres uden slange.

Kan også leveres i gul.

Medie - Tryk	PULVERLAKERET		RUSTFRI STÅL		Tilslutning	
	Best nr.	Pris	Best nr.	Pris	Tilgang	Afgang
Luft - Vand 20 bar - Messing svirvel - "viton" pakning	I75300/10	2.437,-	I75320/10	4.427,-	indv. 1/2"	indv. 1/2"
Vand max 130° C 100 bar - AISI 304 rustfri stål svirvel - "viton" pakning	I75300/20	2.711,-	I75340/20 *	4.715,-	indv. 1/2"	indv. 1/2"
Vand max 130° C 200 bar - AISI 304 rustfri stål svirvel - "viton" pakning	I75300/30	2.624,-	I75340/30	4.614,-	indv. 3/8"	indv. 1/2"
Vand max 130° C 400 bar - AISI 304 rustfri stål svirvel - "teflon" pakning	I75300/35	2.942,-	I75340/35	4.989,-	indv. 3/8"	indv. 1/2"
Olie og lign. 150 bar - galvaniseret stål svirvel - "polyurethane" pakning	I75300/40	2.451,-	-	-	indv. 1/2"	indv. 1/2"
Fedt 600 bar - galvaniseret stål svirvel - "polyurethane" pakning	I75300/50	3.203,-	I75320/50	4.499,-	indv. 3/8"	indv. 1/2"
Diesel olie 10 bar - Messing svirvel - "viton" pakning	I75300/60	2.942,-	I75320/60	6.662,-	indv. 1"	indv. 1"

* også velegnet til olie

Slangeopruller kapacitet

udvendig slange dimension		Series 530
	1/4"	Længde max 60 m
	3/8"	Længde max 35 m
	1/2"	Længde max 25 m
	5/8"	Længde max 18 m
	3/4"	Længde max 15 m
	1"	Længde max 7 m

Dimension

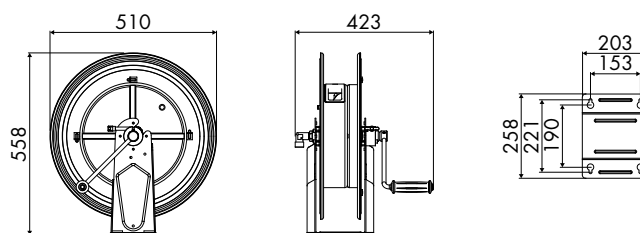

N°1 packing m³ 0,156

kg 15,5

Monteringsplade + drejeligt vægbeslag se side 114-115

**PULVER-
LAKERET**

**AISI 304
RUSTFRI
STÅL**



Note: Alle oprullere leveres uden slange.

Kan også leveres i gul.

Medie - Tryk	PULVERLAKERET		RUSTFRI STÅL		Tilslutning	
	Best nr.	Pris	Best nr.	Pris	Tilgang	Afgang
Luft - Vand 20 bar - Messing svirvel - "viton" pakning	175400/10	3.230,-	175420/10	6.042,-	indv. 1"	indv. 1"
	175400/15	2.927,-	175420/15	5.307,-	indv. 1/2"	indv. 1/2"
Vand max 130° C 100 bar - AISI 304 rustfri stål svirvel - "viton" pakning	175400/20	3.951,-	175440/20 *	6.777,-	indv. 1"	indv. 1"
	175400/25	3.201,-	175440/25 *	5.595,-	indv. 1/2"	indv. 1/2"
Vand max 130° C 200 bar - AISI 304 rustfri stål svirvel - "viton" pakning	175400/30	3.100,-	175440/30	5.494,-	indv. 3/8"	indv. 1/2"
Vand max 130° C 400 bar - AISI 304 rustfri stål svirvel - "teflon" pakning	175400/35	3.403,-	175440/35	5.710,-	indv. 3/8"	indv. 1/2"
Olie og lign. 150 bar - galvaniseret stål svirvel - "polyurethane" pakning	175400/40	3.374,-	-	-	indv. 1"	indv. 1"
	175400/45	2.956,-	-	-	indv. 1/2"	indv. 1/2"
Fedt 600 bar - galvaniseret stål svirvel - "polyurethane" pakning	175400/50	2.985,-	175420/50	5.364,-	indv. 3/8"	indv. 1/2"
Diesel olie 10 bar - Messing svirvel - "viton" pakning	175400/10	3.230,-	175420/10	6.042,-	indv. 1"	indv. 1"

* også velegnet til olie

Slangeopruller kapacitet

udvendig slange dimension		Series 540
1/4"	14 mm	Længde max 110 m
3/8"	17 mm	Længde max 60 m
1/2"	20 mm	Længde max 45 m
5/8"	21 mm	Længde max 25 m
3/4"	27 mm	Længde max 20 m
1"	34 mm	Længde max 15 m

Dimension

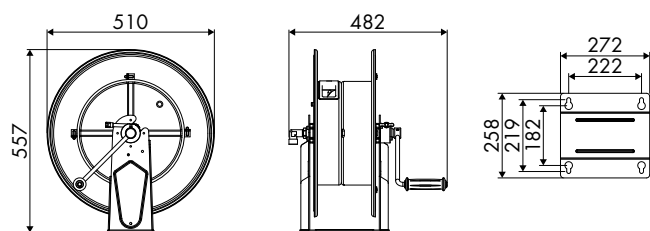

N°1 packing m³ 0,214 kg 21

Monteringsplade + drejeligt vægbeslag se side 114-115

**PULVER-
LAKERET**

**AISI 304
RUSTFRI
STÅL**



Note: Alle oprullere leveres uden slange.

Kan også leveres i gul.

Medie - Tryk	PULVERLAKERET		RUSTFRI STÅL		Tilslutning	
	Best nr.	Pris	Best nr.	Pris	Tilgang	Afgang
Luft - Vand 20 bar - Messing svirvel - "viton" pakning	175600/10	5.033,-	175620/10	8.349,-	indv. 1"	indv. 1"
	175600/16	4.600,-	175620/16	7.686,-	indv. 1/2"	indv. 1/2"
Vand max 130° C 100 bar - AISI 304 rustfri stål svirvel - "viton" pakning	175600/20	5.782,-	175640/20 *	9.113,-	F 1"G	F 1"G
	175600/26	4.874,-	175640/26 *	7.989,-	indv. 1/2"	indv. 1/2"
Vand max 130° C 200 bar - AISI 304 rustfri stål svirvel - "viton" pakning	175600/30	4.890,-	175640/30	7.873,-	indv. 3/8"	indv. 1/2"
Vand max 130° C 400 bar - AISI 304 rustfri stål svirvel - "teflon" pakning	175600/35	5.105,-	175640/35	8.191,-	indv. 3/8"	indv. 1/2"
Olie og lign. 150 bar - galvaniseret stål svirvel - "polyurethane" pakning	175600/40	5.162,-	-	-	indv. 1"	indv. 1"
	175600/46	4.629,-	-	-	indv. 1/2"	indv. 1/2"
Fedt 600 bar - galvaniseret stål svirvel - "polyurethane" pakning	175600/50	4.658,-	175620/50	8.104,-	indv. 3/8"	indv. 1/2"
Diesel olie 10 bar - Messing svirvel - "viton" pakning	175600/10	5.033,-	175620/10	8.349,-	indv. 1"	indv. 1"

* også velegnet til olie

Slangeopruller kapacitet

udvendig slange dimension		Series 560
1/4"	14 mm	Længde max 200 m
3/8"	17 mm	Længde max 120 m
1/2"	20 mm	Længde max 85 m
5/8"	21 mm	Længde max 60 m
3/4"	27 mm	Længde max 45 m
1"	34 mm	Længde max 30 m

Dimension

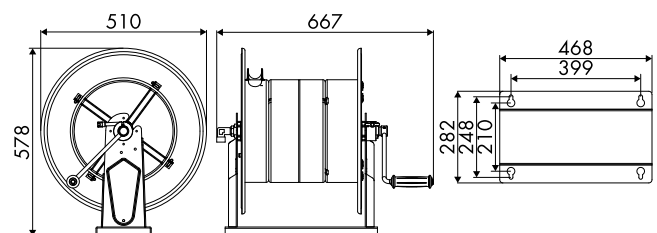

N°1 packing m³ 0,264 kg 39

Monteringsplade se side 114-115

1125 & 1175 Serien

Serie 1125 er manuelle og motoriserede oprullere som henvender sig til den professionelle industri. Oprulleren er designet med en solid "A" ramme og med en ekstrem nem og korrekt slangetilslutning

VIST MED SLANGESTYR - SOM ER TILKØB



1125 & 1175 SERIEN TILBYDER ...

- "A" konstruktion som er lavet i et stykke og svejst
- Nem og korrekt slangetilslutning så man undgår kink på slangen
- Permanent smøring sikrer blød rotation
- Justerbar tromlebremse
- Messing svirvel
- Forzinket svirvel på 1" modellen

1125 MANUEL MODEL // Luft & Vand & Olie

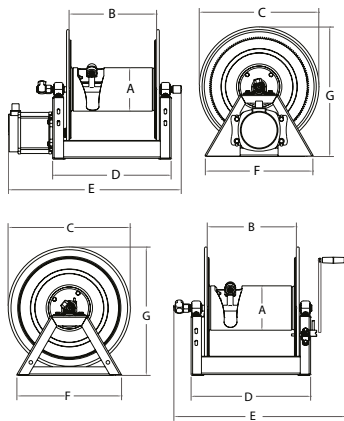

Fåes også i
RUSTFRI
se side 110

MODEL u/slange	I.D.	U.D.	Længde	I.D.*	U.D.*	Længde*	BAR	Tilgang FNPT 90°	Afgang FNPT	KG	Str.	Pris
1125-4-100	12 mm	21 mm	30 m	10 mm	17 mm	42 m	210	1/2"	1/2"	16	1	4.154,-
1125-4-200	12 mm	21 mm	61 m	10 mm	17 mm	91 m	210	1/2"	1/2"	18	2	4.154,-
1125-4-325	12 mm	21 mm	99 m	10 mm	17 mm	136 m	210	1/2"	1/2"	22	3	4.281,-
1125-4-450	12 mm	21 mm	136 m	10 mm	17 mm	189 m	210	1/2"	1/2"	24	4	4.281,-
1125-4-500	12 mm	21 mm	152 m	10 mm	17 mm	212 m	210	1/2"	1/2"	26	5	4.362,-
1125-5-50	19 mm	29 mm	15 m	12 mm	21 mm	30 m	210	3/4"	3/4"	17	6	5.316,-
1125-5-100	19 mm	29 mm	30 m	12 mm	21 mm	61 m	210	3/4"	3/4"	19	7	5.317,-
1125-5-175	19 mm	29 mm	53 m	12 mm	21 mm	98 m	210	3/4"	3/4"	23	8	5.460,-
1125-5-200	19 mm	29 mm	61 m	12 mm	21 mm	136 m	210	3/4"	3/4"	25	9	5.460,-
1125-5-250	19 mm	29 mm	76 m	12 mm	21 mm	152 m	210	3/4"	3/4"	27	10	5.571,-
1125-6-35	25 mm	37 mm	10 m	19 mm	29 mm	15 m	210	1"	1"	23	11	7.020,-
1125-6-50	25 mm	37 mm	15 m	19 mm	29 mm	23 m	210	1"	1"	25	12	7.148,-
1125-6-75	25 mm	37 mm	23 m	19 mm	29 mm	36 m	210	1"	1"	28	13	7.259,-
1175-6-50	25 mm	37 mm	15 m	19 mm	32 mm	30 m	210	1"	1"	30	1	7.658,-
1175-6-100	25 mm	37 mm	30 m	19 mm	32 mm	45 m	210	1"	1"	32	2	7.657,-
1175-6-125	25 mm	37 mm	38 m	19 mm	32 mm	61 m	210	1"	1"	33	3	8.356,-
1175-6-135	25 mm	37 mm	41 m	19 mm	32 mm	53 m	210	1"	1"	32	6	8.356,-
1175-6-150	25 mm	37 mm	45 m	19 mm	32 mm	76 m	210	1"	1"	34	4	8.356,-
1175-6-200	25 mm	37 mm	60 m	19 mm	32 mm	91 m	210	1"	1"	38	5	8.356,-

SLANGEVAGNE & BÆREHÅNDTAG

Model	Slangevogn	Pris
PR-1125-6	1125-4-100 & 1125-5-50	1.746,00
PR-1125-12	1125-4-200	1.746,00

Model	Bærehåndtag	Pris
PR-1125-HC	1125-4-100 & 1125-5-50	715,00

MOTOR DREVNE MODELER // Tilføj bogstav kode til manuel bestillingsnr. oven over

Bogstav kode	Motor Type	Beskrivelse	Extra KG	Tillægspris til manuel opruller
A	LUFT #4	Luft Motor	4	7.244,-
E	ELEKTRISK - 12VDC	1/3 HP	6	7.053,-
EB	ELEKTRISK - 24VDC	1/2 HP	12	7.530,-
ED	ELEKTRISK EX-P	1/2 HP	12	10.093,-
EA	ELEKTRISK EX-P 115VDC	1/2 HP	12	7.245,-
EA230	ELEKTRISK - 230V	1/2 HP	12	10.109,-
H	HYDRAULISK		3	9.742,-

DIMENSION

Str.	A	B	C	D	Manuel E	Elektrisk E	Luft E	F	Manuel G	Elektrisk G	Luft G
1	159	152	445	289	552	467	419	385	460	476	476
2	159	305	445	441	705	619	264	385	460	476	476
3	159	457	445	594	857	770	728	385	460	476	476
4	159	610	445	746	1010	924	876	385	460	476	476
5	159	711	445	848	1111	1025	978	385	460	476	476
6	159	152	445	289	540	467	419	385	460	476	476
7	159	305	445	441	692	619	264	385	460	476	476
8	159	457	445	594	845	770	728	385	460	476	476
9	159	610	445	746	997	924	876	385	460	476	476
10	159	711	445	848	1098	1026	978	385	460	476	476
11	159	241	445	378	641	556	508	385	460	476	476
12	159	394	445	530	794	708	660	385	460	476	476
13	159	559	445	695	959	873	364	385	460	476	476
14	159	711	445	848	1111	1026	978	385	460	476	476
15	267	190	610	173	628	518	470	511	666		
16	267	292	610	428	730	619	264	511	666		
17	267	343	610	480	781	670	622	511	666		
18	267	394	610	530	832	720	673	511	666		
19	267	508	610	644	946	373	787	511	666		
20	267	508	508	644	946	373	787	454	559		



1185 & 1195 Serien

Serie 1185 & 1195 er manuelle og motoriserede oprullere som henvender sig til den professionelle industri, hvor der kræves stor mængde af slange. Oprulleren er designet med en solid "A" ramme og med en ekstrem nem og korrekt slangetilslutning.

1185 SERIEN TILBYDER ...

- "A" konstruktion som er lavet i et stykke og svejst
- Nem og korrekt slangetilslutning så man undgår kink på slangen
- Justerbar tromlebremse
- Svirvel er fastboltet direkte til huset
- Horizontal monteret lejer i stedet for flange monteret



Type

Manuel

Motor

Media

Luft

Vand

Olie

Fedt

Brændstof

Svirvel materiale

Stål

Pakning materiale

Nitril

1185 MANUEL OPRULLER // Luft & Vand & Olie

MODEL u/slange	I.D.	U.D.	Længde	I.D.*	U.D.*	Længde*	BAR	Tilgang FNPT	Afgang FNPT	KG	Str.	Pris u/slange
1185-1124	38 mm	51 mm	15 m	32 mm	44 mm	23 m	41	1.5"	1.5"	35	1	9.772,-
1185-1524	38 mm	51 mm	23 m	32 mm	44 mm	30 m	41	1.5"	1.5"	37	2	9.772,-
1185-2020	38 mm	51 mm	20 m	32 mm	44 mm	24 m	41	1.5"	1.5"	32	3	9.772,-
1185-2024	38 mm	51 mm	30 m	32 mm	44 mm	38 m	41	1.5"	1.5"	43	4	9.772,-
1185-2028	38 mm	51 mm	38 m	32 mm	44 mm	55 m	41	1.5"	1.5"	49	5	11.380,-
1185-2528	38 mm	51 mm	46 m	32 mm	44 mm	67 m	41	1.5"	1.5"	55	6	11.380,-
1185-3324	38 mm	51 mm	53 m	32 mm	44 mm	68 m	41	1.5"	1.5"	70	7	9.772,-
1185-3328	38 mm	51 mm	76 m	32 mm	44 mm	99 m	41	1.5"	1.5"	77	8	

1195 MANUEL OPRULLER // Luft & Vand & Olie

MODEL no hose	I.D.	U.D.	Længde	I.D.*	U.D.*	Længde*	BAR	Tilgang FNPT	Afgang FNPT	KG	Str.	Pris u/slange
1195-932	51 mm	65 mm	15 m	38 mm	57 mm	18 m	41	2"	2"	58	9	24.942,-
1195-1332	51 mm	65 mm	23 m	38 mm	57 mm	30 m	41	2"	2"	67	10	24.942,-
1195-2032	51 mm	65 mm	35 m	38 mm	57 mm	45 m	41	2"	2"	84	11	24.942,-
1195-1728	51 mm	65 mm	18 m	38 mm	57 mm	26 m	41	2"	2"	61	12	24.942,-
1195-2428	51 mm	65 mm	27 m	38 mm	57 mm	41 m	41	2"	2"	77	13	24.942,-
1195-3228	51 mm	65 mm	38 m	38 mm	57 mm	53 m	41	2"	2"	99	14	24.942,-

1185/1195 SERIE MANUEL

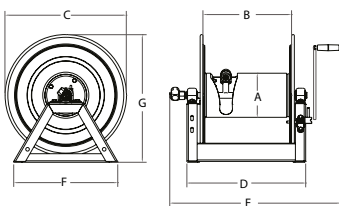

1185 SERIE MOTOR

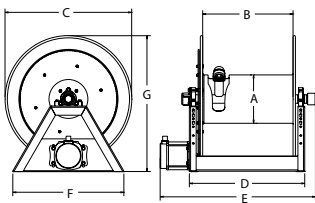

1195 SERIE MOTOR

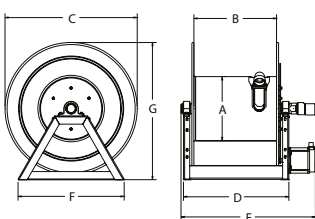

MOTORDREVET OPRULLER // Tilføj bogstav kode til manuel bestillingsnr. oven over

Bogstav kode	Motor Type	Beskrivelse	Extra KG	Tillægspris
A	LUFT #4	Luft Motor	4	7.274,-
AB	LUFT #6	Luft Motor	8	7.879,-
E	ELEKTRISK - 12VDC	1/3 HP	6	7.053,-
EB	ELEKTRISK - 24VDC	1/2 HP	12	7.530,-
ED	ELEKTRISK Explosion Proof	1/2 HP	12	10.093,-
EA	ELEKTRISK Explosion Proof - 115V DC	1/2 HP	12	8.245,-
EA230	ELEKTRISK - 230V	1/2 HP	12	10.109,-
H	HYDRAULISK	End Ported 9/16-18 UNF	3	9.742,-

DIMENSION

Str.	A	B	C	D	Manuel E	Elektrisk E	Luft E	F	G
1	267	292	610	292	611	589	617	564	635
2	267	394	610	535	713	766	720	564	635
3	267	292	508	650	827	881	833	498	549
4	267	508	610	636	827	881	833	564	635
5	267	508	711	636	827	881	833	622	737
6	267	635	711	764	954	1008	960	568	737
7	267	838	610	967	1157	1211	1163	622	635
8	267	838	711	967	1157	1211	1163	622	737
9	394	241	813	385	508	508	508	650	845
10	394	343	813	485	610	610	610	650	845
11	394	508	813	650	774	774	774	650	845
12	394	445	711	587	711	711	711	622	768
13	394	610	711	752	876	876	876	622	768
14	394	813	711	955	464	464	1079	622	768

1125 & 1175 Serien

Serie 1125 & 1175 i rustfri udførelse er manuelle og motoriserede oprullere som henvender sig til den professionelle industri.

Oprulleren er designet med en solid "A" ramme og med en ekstrem nem og korrekt slangetilslutning, så man undgår at slangen bliver flad eller kinker.

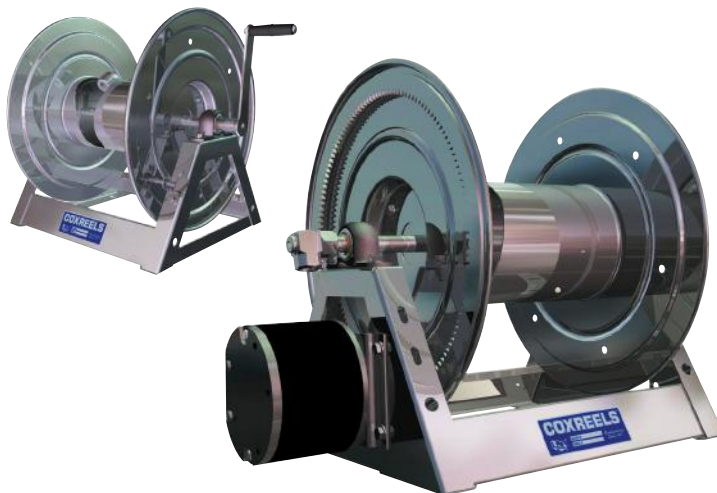

1125 & 1175 SERIEN Tilbyder ...

- Rustfri stålramme, tromle og flanger
- Solid rustfri svirvel
- Viton pakninger velegnet til diesel og benzin

SERIE 1125 – MANUEL OPRULLER // Luft, Vand & Olie

MODEL u/slange	I.D.	U.D.	Længde	I.D.*	U.D.*	Længde*	BAR	Tilgang F NPT 90°	Afgang F NPT	KG	Str.	Pris u/slange
1125-4-100-SS	12 mm	21 mm	30 m	10 mm	19	42 m	300	1/2"	1/2"	16	1	16.730,-
1125-4-200-SS	12 mm	21 mm	60 m	10 mm	19	91 m	300	1/2"	1/2"	18	2	18.352,-
1125-4-325-SS	12 mm	21 mm	99 m	10 mm	19	136 m	300	1/2"	1/2"	22	3	19.005,-
1125-4-450-SS	12 mm	21 mm	136 m	10 mm	19	189 m	300	1/2"	1/2"	24	4	20.262,-
1125-4-500-SS	12 mm	21 mm	152 m	10 mm	19	212 m	300	1/2"	1/2"	26	5	21.759,-
1125-5-50-SS	19 mm	29 mm	15 m	12 mm	22	30 m	300	3/4"	3/4"	17	6	18.560,-
1125-5-100-SS	19 mm	29 mm	30 m	12 mm	22	61 m	300	3/4"	3/4"	19	7	19.961,-
1125-5-175-SS	19 mm	29 mm	53 m	12 mm	22	98 m	300	3/4"	3/4"	23	8	20.899,-
1125-5-200-SS	19 mm	29 mm	61 m	12 mm	22	136 m	300	3/4"	3/4"	25	9	22.045,-
1125-5-250-SS	19 mm	29 mm	76 m	12 mm	22	152 m	300	3/4"	3/4"	27	10	23.525,-
1125-6-35-SS	25 mm	37 mm	10 m	19 mm	32	15 m	300	1"	1"	23	11	28.827,-
1125-6-50-SS	25 mm	37 mm	15 m	19 mm	32	23 m	300	1"	1"	25	12	31.277,-
1125-6-75-SS	25 mm	37 mm	23 m	19 mm	32	36 m	300	1"	1"	28	13	33.586,-
1125-6-100-SS	25 mm	37 mm	30 m	19 mm	32	45 m	300	1"	1"	31	14	35.957,-

SERIE 1175 – MANUEL OPRULLER // Luft, Vand & Olie

MODEL u/slange	I.D.	U.D.	Længde	I.D.*	U.D.*	Længde*	BAR	Tilgang F NPT 90°	Afgang F NPT	KG	Str.	Pris u/slange
1175-6-50-SS	25 mm	37 mm	15 m	19 mm	29 mm	30 m	300	1"	1"	30	1	31.978,-
1175-6-100-SS	25 mm	21 mm	30 m	19 mm	29 mm	45 m	300	1"	1"	32	2	32.647,-
1175-6-125-SS	25 mm	21 mm	38 m	19 mm	29 mm	61 m	300	1"	1"	33	3	33.506,-
1175-6-135-SS	25 mm	21 mm	41 m	19 mm	29 mm	53 m	300	1"	1"	32	4	33.600,-
1175-6-150-SS	25 mm	21 mm	45 m	19 mm	29 mm	76 m	300	1"	1"	34	5	34.939,-
1175-6-200-SS	25 mm	29 mm	60 m	19 mm	29 mm	91 m	300	1"	1"	38	6	34.537,-

MOTOR DREVNE MODELER // Tilføj bogstav kode til manuel bestillingsnr. oven over

Bogstav kode	Motor Type	Beskrivelse	Extra KG	Tillægspris til manuel opruller
A	LUFT #4	Luft Motor	04	7.274,-
E	ELEKTRISK - 12V DC	1/3 HP	06	7.053,-
EB	ELEKTRISK - 24V DC	1/2 HP	12	7.530,-
ED	ELEKTRISK Explosion Proof	1/2 HP	12	10.093,-
EA	ELEKTRISK Explosion Proof - 115V DC	1/2 HP	12	8.245,-
EA230	ELEKTRISK - 230V	1/2 HP	12	10.109,-
H	HYDRAULISK	End Ported 9/16-18 UNF	03	9.742,-

SP Serien

SP serien af automatiske slangeoprullere henvender sig til den professionelle industri og er bygget til at håndtere store dimensioner slanger.

Oprulleren er beregnet til lav og medium tryk samt til medier som diesel, benzin eller vand.

Den kraftige stålramme har tværgående styrkelse i alle 4 hjørner som sikrer en ekstrem god stabilitet selv ved store belastninger.

SP SERIEN TILBYDER ...

- Robust stålramme sikrer maksimum styrke og stabilitet
- Fabriksindstillet oliesmurt fjeder
- Selvslemmende flangelejlere med lang levetid
- Formstøbt låsemekanisme med gnistfri bronzepal
- Kraftige 1" udv. rustfrie styreruller
- Justerbar til væg, gulv- eller loftmontering

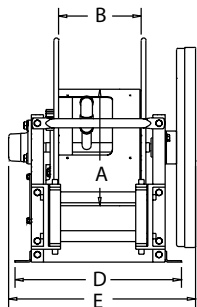
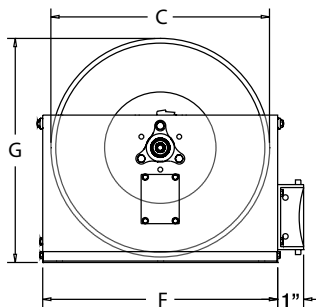

LAVTRYK // Luft & Vand

MODEL u/slange	I.D.	U.D.	Længde	BAR	Tilgang	Afgang	KG u/slange	Str.	Pris u/slange
SLPL-4100-BGX	12mm	17mm	31 m	21	1/2"	1/2"	44	1	10.680,-
SLPL-550-BGX	19mm	29mm	15 m	21	3/4"	3/4"	39	2	10.680,-
SLPL-575-BGX	19mm	29mm	23 m	21	3/4"	3/4"	53	3	11.269,-
SLPL-5100-BGX	19mm	29mm	31 m	21	3/4"	3/4"	57	4	14.150,-
SLPL-650-BGX	25mm	37mm	15 m	21	1"	1"	49	6	11.844,-
SLPL-675-BGX	25mm	37mm	23 m	21	1"	1"	67	7	13.402,-
SLPL-750-BGX	32mm	44mm	15 m	18	1.25"	1.25"	56	9	13.195,-
SLPL-850-BGX	38mm	51mm	15 m	18	1.5"	1.5"	63	10	15.281,-

Maximum temp. 65°C Opruller u/slange kan bruges til luft, vand & olie

MEDIUMTRYK // Luft, Vand & Olie

MODEL u/slange	I.D.	U.D.	Længde	BAR	Tilgang	Afgang	KG u/slange	Str.	Pris u/slange
SMPL-4100-BGX	12mm	17mm	31 m	140	1/2"	1/2"	51	1	11.334,-
SMPL-550-BGX	19mm	29mm	15 m	105	3/4"	3/4"	40	5	11.334,-
SMPL-575-BGX	19mm	29mm	23 m	105	3/4"	3/4"	55	6	13.959,-
SMPL-5100-BGX	19mm	29mm	31 m	105	3/4"	3/4"	57	6	14.910,-
SMPL-650-BGX	25mm	37mm	15 m	70	1"	1"	50	6	12.607,-
SMPL-675-BGX	25mm	37mm	23 m	70	1"	1"	61	9	14.390,-

DIMENSION

Str.	A	B	C	D	E	F	G
1	267	190	508	390	495	264	521
2	267	190	508	390	483	264	521
3	267	190	610	390	483	660	622
4	267	190	610	390	508	660	622
5	267	190	508	390	521	264	521
6	267	190	610	390	533	660	622
7	267	190	711	390	533	762	728
8	267	190	610	390	457	660	622
9	267	190	711	390	457	762	728
10	267	241	711	441	508	762	728

- Opruller Type Fjeder
- Media Luft
Vand
Olie
- Svivel materiale Stål
- Pakning materiale Nitril

*AFLAS on 25mm Models

MONTERINGS BESLAG

SVING BESLAG

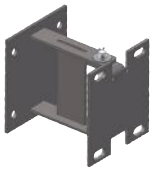

- Til vægmontering
- Drejelig 180°
- Vægt: 2.5 Kg.

Best Nr.	TIL SERIE
15720	P, SH, MP & HP, EN, PC, P-W & SHW, P-WC, ALUMI-PRO & EZ-versionen Maximal vægt: 31 Kg
15725	T, C & EZ-version Maximal vægt: 55 Kg

SVIRVEL BESLAG



- Til gulv/loft montering
- Drejelig 345°
- Vægt: 3 Kg.

Best Nr.	TIL SERIE
15721	P, SH, MP & HP, EN, PC, P-W & SHW, P-WC, ALUMI-PRO, T, C & EZ-versionen Maximal vægt: 55 Kg

DREJELIG SLANGE GUIDE



- Med 5 låse positioner
- Kun til motor opruller variant E & ED
- Vægt: 7,7 kg

Best Nr.	TIL SERIE	POSITION
15732	1125	BUND
15733	1125	TOP

DREJELIG SLANGE GUIDE

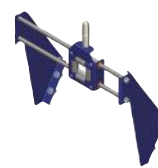

- 4-vejs solid rulle guide
- Vægt: 4,5 kg

Best Nr.	TIL SERIE
15734	1125

4-VEJS STYRERULLER

TOP MONTERING



- 4-vejs rustfri ruller i 1"
- Vægt: 4,5 kg

Best Nr.*	TIL SERIE
15353-6	1125-4-100 & 1125-5-50
15353-12	1125-4-200 & 1125-5-100
15353-18	1125-4-325 & 1125-5-175
15353-24	1125-4-450 & 1125-5-200
15353-28	1125-4-500 & 1125-5-250

Best Nr.*	TIL SERIE
15355	1275W-C
15357	1175
15357-11.5	1175-V
15368	1195 (28")
15368-1	1195 (32")
15369	1185 (24")
15369-1	1185 (28")

BUND MONTERING

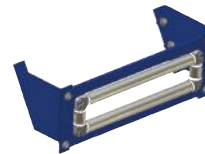

- 4-vejs rustfri opruller i 1"
- Vægt: 4.5 Kg

Best Nr.*	TIL SERIE
15037	1175
15037-11.5	1175-V
15354	1125, 1125WCL, 1275
15370	1195
15370-1	1185

TOP MONTERING

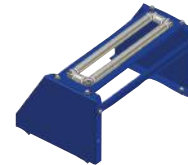

- Til gulv, væg eller loft montering
- Vægt: 4,5 kg

Best Nr.*	Str.	TIL SERIE
20458 & 8100	Til 3/8" - 3/4"	SP, DP
20458 & 8101	Til 1" - 1 1/2"	SP, DP
20458-724 & 8101-7.5	Til 1" - 1 1/2"	SP-V, DP-V

4-VEJS STYRERULLER

TOP MONTERET M/FORLÆNGER



- Vægt: 4,5 kg

Best. Nr.	TIL SERIE
15353-P	1125

STYRERULLE PLADE

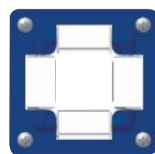

- Incl. 4 styreruller
- Kan leveres i rustfri udførelse
- Vægt: 0.5 Kg

Best. Nr.	Str. I.D.	TIL SERIE
4RB	For 1/4" - 3/4"	S
4RB-SS	For 1/4" - 3/4"	S

3-VEJS STYRERULLER

TOP MONTERING



- 3-vejs styrerulle guide med åben top
- Vægt: 6.4 Kg

Best. Nr.*	TIL SERIE
15359	1125, 1275
15360	1175, 1185 (24")
15360-11.5	1175-V
15361	1185 (28")

BUND MONTERING



- 3-vejs styrerulle guide med åben top
- Vægt: 6.4 Kg

Best. Nr.*	TIL SERIE
15362	1125, 1275
15363	1175, 1185 (24")
15363-11.5	1175-V
15364	1185 (28")

ELEKTRISKE KOMPONENTER / HASTIGHEDSKONTROL









12V ELEKTRISK MOTOR MED VARIABEL HASTIGHEDSKONTROL
BEST. NR. 20870









#7406 (For 1125 Series) or #7700 (For 1175 Series, 24") or #8176-1 (For 1185 Series, 24") or #8176-2 (For 1185 Series, 28") or #8176 (For 1195 Series)
Beskytter mod snavs og samtidig gør det mere sikkert for brugeren



INDUSTRISERIE (ÅBEN OG LUKKET)



 Ø 12 mm	max 16 m	Serie 270 indv. 3/8"
 Ø 14 mm	max 14 m	
 Ø 16 mm	max 10 m	



 Ø 12 mm	max 18 m	Serie 300 indv. 3/8"-1/2"
 Ø 14 mm	max 16 m	
 Ø 16 mm	max 12 m	



 Ø 12 mm	max 22 m	Serie 350 indv. 3/8"-1/2"
 Ø 14 mm	max 20 m	
 Ø 16 mm	max 18 m	



 Ø 17 mm	max 21 m	Serie 440 Serie 430 indv. 1/2"
 Ø 19,5 mm	max 16 m	
 Ø 22 mm	max 14 m	

 Ø 18,5 mm	max 28 m	Serie 530 indv. 1/2"
 Ø 20 mm	max 26 m	
 Ø 22 mm	max 24 m	



 Ø 17 mm	max 30 m	Serie 540 indv. 1/2"
 Ø 19,5 mm	max 30 m	
 Ø 22 mm	max 30 m	



 Ø 28 mm	max 22 m	Serie 540 indv. 1"
 Ø 34 mm	max 17 m	



 Ø 17 mm	max 50 m	Serie 560 indv. 1/2"
 Ø 19,5 mm	max 60 m	
 Ø 22 mm	max 60 m	

 Ø 30 mm	max 40 m	Serie 560 indv. 1"
 Ø 35 mm	max 30 m	

INDUSTRISERIE TIL OXYGEN / ACETYLENE - TVILLING SLANGE

 Ø 13 +13 mm	max 13 m	Serie 430 indv. 3/8"
 Ø 15 +15 mm	max 12 m	
 Ø 16 +16 mm	max 10 m	

 Ø 13 +13 mm	max 22 m	Serie 530 indv. 3/8"
 Ø 15 +15 mm	max 20 m	
 Ø 16 +16 mm	max 15 m	





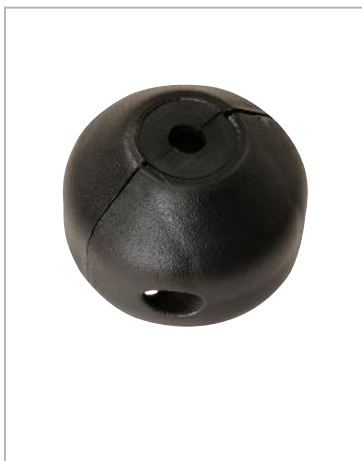





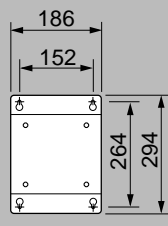

 Ø 13 +13 mm	max 22 m	Serie 540 indv. 3/8"
 Ø 15 +15 mm	max 20 m	
 Ø 16 +16 mm	max 15 m	

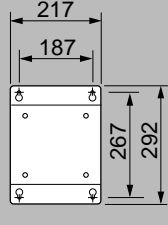
SLANGE- OG KABELSTOP

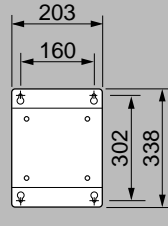

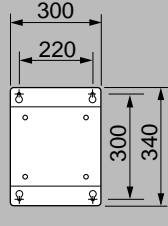
Best nr.	Beskrivelse	Kr/stk
EX806002	Slangestop 1/4"	72,-
EX806003	Slangestop 3/8"	78,-
EX806004	Slangestop 1/2"	92,-
EX806006	Slangestop 3/4"	105,-
EX806008	Slangestop 1"	117,-
173330	Kabelstop	90,-

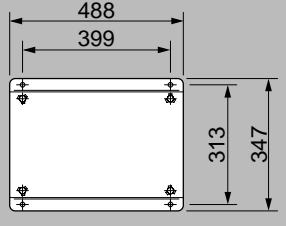

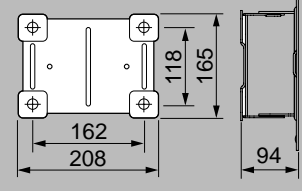
Image	Serie Bajonetbeslag til slangeopruller Serie 260	Best nr. Best. Nr. I260/01	Pris 158,-	Diagram
 	Monteringsplade til slangeopruller Serie 270-300-350-430 Monteringsplade til slangeopruller Serie 270-300-350-430 AISI304	Best. Nr. I430/01 Best. Nr. I430/02	158,- 324,-	
	Monteringsplade til slangeopruller Serie 440	Best. Nr. I440/01	119,-	
 	Monteringsplade til slangeopruller Serie 530 Monteringsplade til slangeopruller Serie 530 AISI304	Best. Nr. I530/01 Best. Nr. I530/02	108,- 447,-	
 	Monteringsplade til slangeopruller Serie 540 Monteringsplade til slangeopruller Serie 540 AISI 304	Best. Nr. I540/01 Best. Nr. I540/02	173,- 667,-	
 	Monteringsplade til slangeopruller Serie 560 Monteringsplade til slangeopruller Serie 560 AISI304	Best. Nr. I560/01 Best. Nr. I560/02	411,- 1.276,-	
 	Drejebeslag til slangeopruller Serie 270-300-350-430 Drejebeslag til slangeopruller Serie 270-300-350-430 AISI304	Best. Nr. I430/05 Best. Nr. I430/06	310,- 609,-	



Drejebeslag til slangeopruller Serie 440

Best. Nr. I440/05

343,-

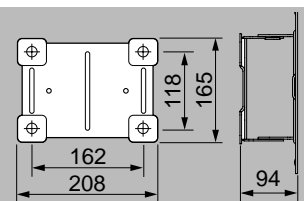

Drejebeslag til slangeopruller Serie 530
Drejebeslag til slangeopruller Serie 530 AISI 304

Best. Nr. I530/05

334,-

Best. Nr. I530/06

757,-

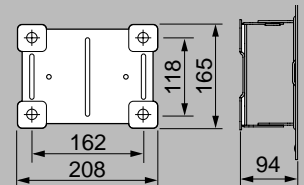

Drejebeslag til slangeopruller Serie 540
Drejebeslag til slangeopruller Serie 540 AISI 304

Best. Nr. I540/05

799,-

Best. Nr. I540/06

1.813,-

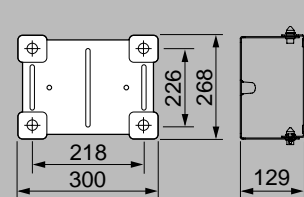

DIREKTE MONTERING

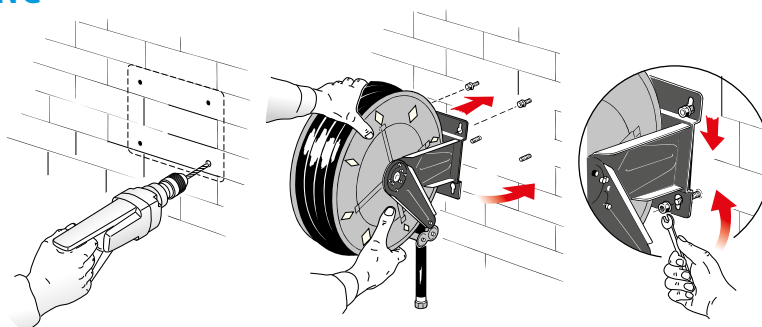

MONTERINGSPLADE

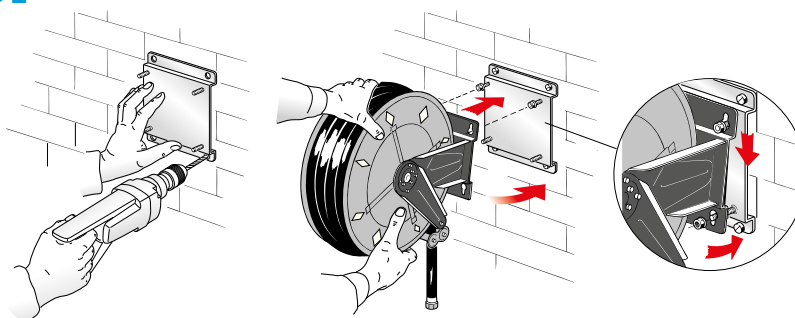

DREJELIGT VÆGBESLAG

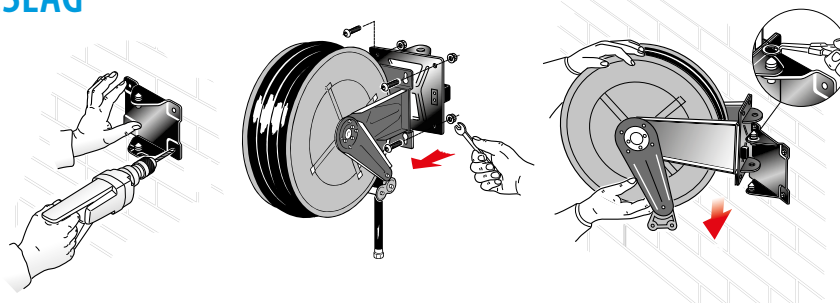

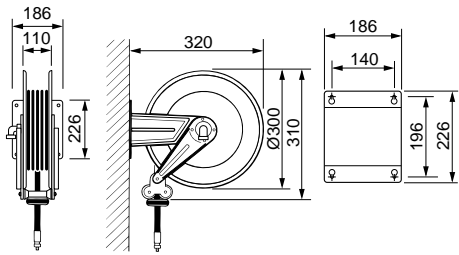

Serie 270

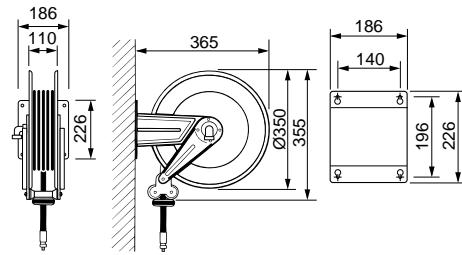

Serie 300

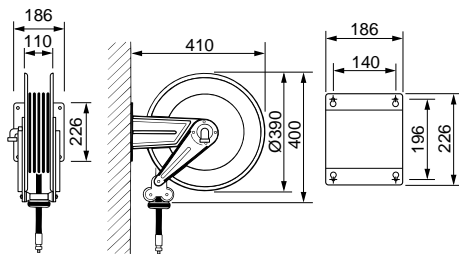

Serie 350

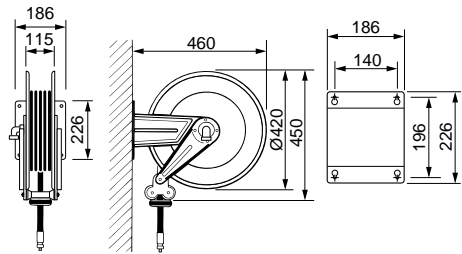

Serie 430

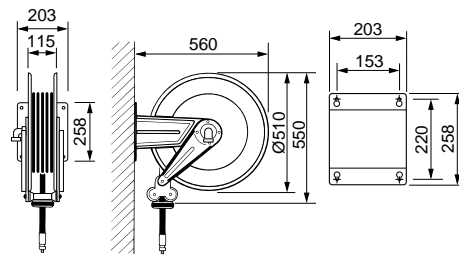

Serie 530

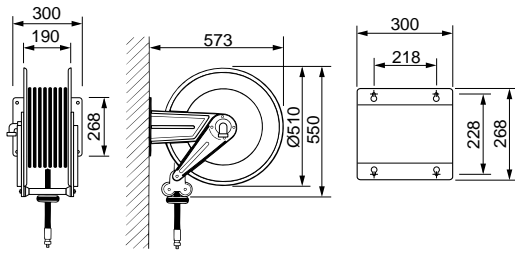

Serie 540

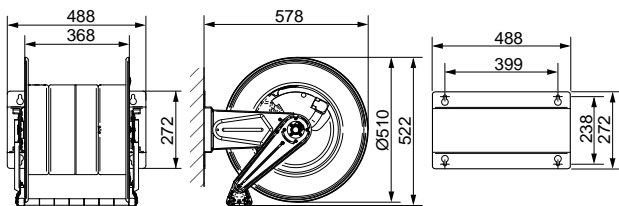

Serie 560



SLAGFAST POLYPROPYLENE

PULVERLAKERET STÅL

STØBT ALUMINIUMSBOKS

ALUMINIUM/STÅL

LEVERINGSTID: På visse kabeloprullere må der påregnes en leveringstid på 3-4 uger fra ordremodtagelse.



SERIE 9000									
Dimension	Lgd. (m)	Kabel	Volt(V)	Stik	⊙ Watt	⚡ Watt	Vægt	Best nr.	Pris
3 x 1,5mm ²	5	PVC	230	u. stik	1000	2000	2 kg	EL9004	1.615,-

Teknisk beskrivelse
 * Boks i slagfast polypropylene med drejeligt væg-/loftbeslag
 * Låser automatisk kabel ved ønsket længde
 * Leveres uden han/hunstik
 * IP42

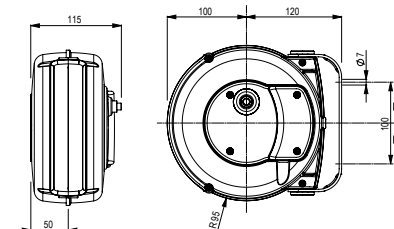

SERIE 610									
Dimension	Lgd. (m)	Kabel	Volt(V)	Stik	⊙ Watt	⚡ Watt	Vægt	Best nr.	Pris
3 x 1,5mm ²	9	PVC	230	DK	1000	2000	5 kg	EL610103	525,-

Teknisk beskrivelse
 * Boks i slagfast polypropylene med drejeligt væg-/loftbeslag
 * Låser automatisk kabel ved ønsket længde
 * Monteret med dansk han/hunstik
 * IP42

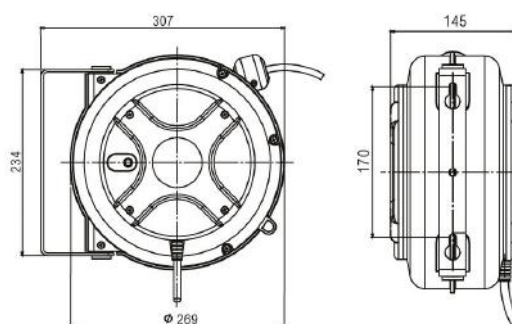

SERIE 605									
Dimension	Lgd. (m)	Kabel	Volt (V)	Stik	⊙ Watt	⚡ Watt	Vægt	Best nr.	Pris
3 x 1,5mm ²	15	PVC	230	DK	1000	2000	5 kg	EL605153-N	798,-
3 x 1,5mm ²	15	PVC	230	SCHUKO	1000	2000	5 kg	EL605153G	798,-
3 x 1,5mm ²	25	PVC	230	DK	1000	2000	8 kg	EL605253	1.598,-

Teknisk beskrivelse
 * Boks i slagfast polypropylene med drejeligt væg-/loftbeslag
 * Låser automatisk kabel ved ønsket længde
 * Monteret med dansk han/hunstik
 * IP42

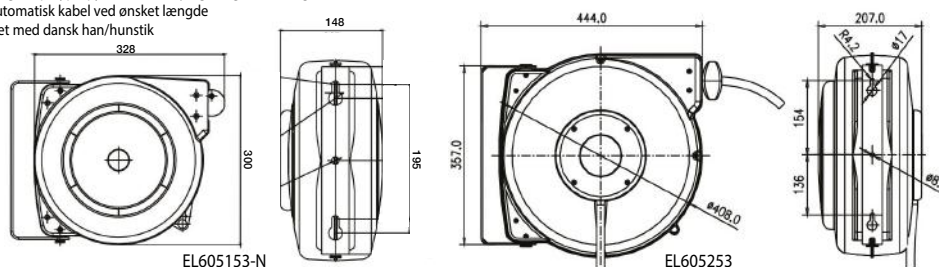

SERIE 605									
Dimension	Lgd. (m)	Kabel	Volt (V)	Stik	⊙ Watt	⚡ Watt	Vægt	Best nr.	Pris
3 x 2,5mm ²	20	Gummi	230	SCHUKO	1600	3200	11 kg	EL625201G	1.995,-

Teknisk beskrivelse
 * Boks i slagfast polypropylene med drejeligt væg-/loftbeslag
 * Låser automatisk kabel ved ønsket længde
 * Monteret med schuko stik
 * IP42



SERIE 633

Dimension	Lgd. (m)	Kabel	Volt(V)	Stik	⊙ Watt	— Watt	Vægt	Best nr.	Pris
3 x 1,5mm ²	20	PVC	230	DK	1000	2000	7 kg	EL633203	998,-
3 x 1,5mm ²	20	PVC	230	SCHUKO	1000	2000	7 kg	EL633203G	998,-

Teknisk beskrivelse
 * Låser automatisk kabel ved ønsket længde
 * Boks i slagfast polypropylene med drejeligt væg-/loftbeslag
 * IP42

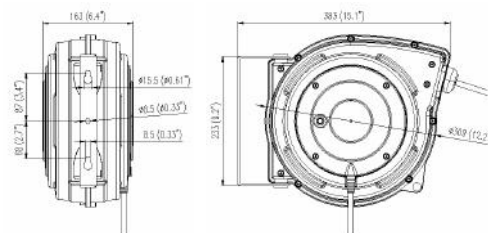

SERIE 280

Dimension	Lgd. (m)	Kabel	Volt(V)	Stik	⊙ Watt	— Watt	Vægt	Best nr.	Pris
3 x 1,5mm ²	14	PVC	230	u/stik	1200	2300	7 kg	EL280143	2.140,-
3 x 1,5mm ²	14	PVC	230	SCHUKO	1200	2300	8 kg	EL280143G	2.205,-
3 x 1,5mm ²	9	Gummi	230	u/stik	1200	2300	7 kg	EL280093	1.848,-
3 x 2,5mm ²	9	PVC	230	u/stik	1900	3500	7 kg	EL280293	1.901,-
3 x 2,5mm ²	7	Gummi	230	u/stik	1900	3500	7 kg	EL280273	1.979,-

Teknisk beskrivelse
 * Låser automatisk kabel ved ønsket længde
 * Boks i slagfast polypropylene med drejeligt væg-/loftbeslag
 * IP44

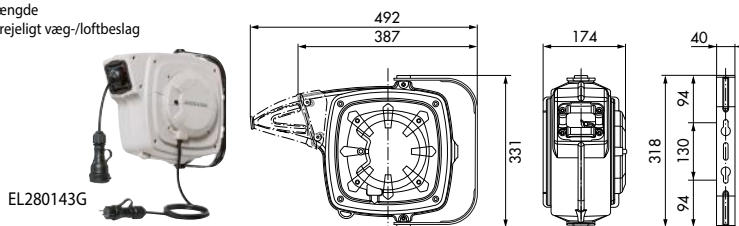

SERIE 280

Dimension	Lgd. (m)	Kabel	Volt(V)	Stik	⊙ Watt	— Watt	Vægt	Best nr.	Pris
5 x 1,5mm ²	8	PVC	400	u/stik	1400	4000	7 kg	EL280085	2.179,-
5 x 1,5mm ²	7	Gummi	400	u/stik	1400	4000	7 kg	EL280075	2.310,-

Teknisk beskrivelse
 * Låser automatisk kabel ved ønsket længde
 * Kraftig pulverlakeret stålstel
 * IP44

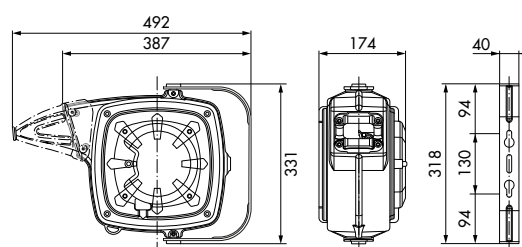

SERIE 170

Dimension	Lgd. (m)	Kabel	Volt(V)	Stik	⊙ Watt	— Watt	Vægt	Best nr.	Pris
5 x 1,5mm ²	20	PVC	400	CEE	1000	3000	10 kg	170420	3.640,-

Teknisk beskrivelse
 * Låser automatisk kabel ved ønsket længde
 * Boks i slagfast polypropylene med drejeligt væg-/loftbeslag
 * Monteret med CEE han/hunstik
 * IP55

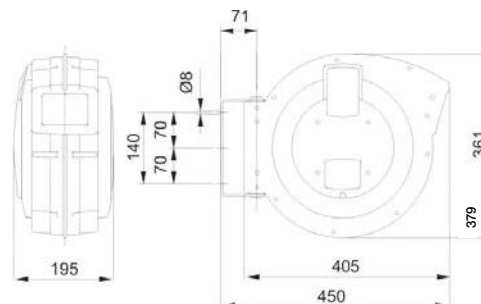



SERIE 885

Dimension	Lgd. (m)	Kabel	Volt(V)	Stik	Watt	Watt	Vægt	Best nr.	Pris
5 x 2,5mm ²	15	PVC	400	CEE	5000	7200	16 kg	EL885151	3.970,-

Teknisk beskrivelse
 * Låser automatisk kabel ved ønsket længde
 * Kraftig pulverlakeret stålstel
 * Monteret med CEE han/hunstik
 * IP55

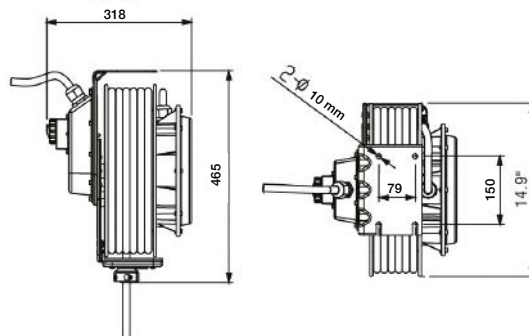

KABELOPRULLER SERIE PRC

Manufactured according to standard:
 Construit selon norme:
 EN 61242 EN 60335-1



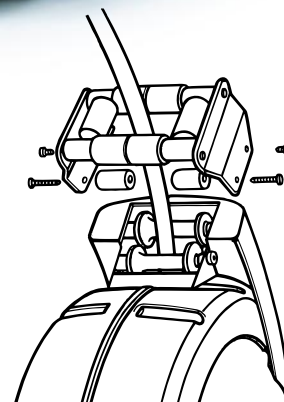

These products comply with Directives:

Produits conformes aux Directives:
 2006/95/CE 2006/42/CE
 2002/95/CE



BESKRIVELSE

- Kraftig kabelopruller i støbt aluminiumsboks
- Styreuller
- Palstop for hver 50 cm. Kan deaktiveres
- IP 42 beskyttelses klasse
- Arbejdstemperatur -5°C - +40°C
- Kan leveres med PVC eller gummi kabel i
- Diverse størrelser og længder. Se næste side

Antal ledere	mm ²	Længde i meter	Best. Nr.	KW		Kabel diameter, mm.	Termo sikring	V max	Kabel Type	Pris	
				 (20°C)	 (20°C)						
1 x	2,5	28 + 2	6198/PRC			5,5	no		H05 V-F	5.833,-	
	6	24 + 2	6195/PRC			5,5	no		H05 V-F	6.448,-	
	16	15 + 2	6193/PRC			8	no		H05 V-F	6.020,-	
2 x	1	27 + 2	6176/PRC	230V	0,6	1	6	no	500	H05 VV-F	5.644,-
		18 + 2	6175/PRC		1,0	1,7	6,5	no	500	H05 VV-F	4.515,-
		24 + 2	6192/PRC								5.080,-
	1,5	24 + 2	6191/PRC		1,1	1,8	7,5	no	500	H05 VV-F	5.268,-
	2,5	21 + 2	6189/PRC		1,8	2,5	9,5	no	500	H05 VV-F	5.268,-
	3 G	1	24 + 2		6187/PRC	400V	1,0	1,7	7	no	500
24 + 2			6186/PRC	8,5	no				500	H05 VV-F	5.737,-
2,5		20 + 2	6186/PRC RNF	1,1	1,8		10	no	750	H07 RN-F	5.833,-
		15 + 2	6184/PRC				2,0	3,0	10	no	500
			6185/PRC								
		12 + 2	6184/PRC RNF								5.456,-
			6185/PRC RNF								5.833,-
4 G		1	24 + 2	6182/PRC	400V		0,8	1,4	8	no	500
	21 + 2		6181/PRC	1,1		1,8			9,5	no	500
	16 + 2	6181/PRC RNF				11	no	750	H07 RN-F	6.020,-	
	2,5	15 + 2	6179/PRC	2,0		3,0	11	no	500	H05 VV-F	5.644,-
			6521/PRC								
		10 + 2	6521/PRC RNF								6.303,-
5 G	1	16 + 2	6063/PRC	400V	0,8	1,4	9	no	500	H05 VV-F	5.644,-
		15 + 2	6067/PRC				1,5	2,2	10,5	no	500
	2,5	10 + 2	6022/PRC		2,0	3,0		12,5	no	500	H05 VV-F
			6068/PRC								
		8 + 2	6068/PRC RNF								6.964,-
7 x	1	16 + 2	6065/PRC		3 A	10	no	500	H05 VV-F	6.397,-	
	1,5	9 + 2	6069/PRC		4,5 A	12	no	500	H05 VV-F	6.211,-	
8 x	1	11 + 2	6066/PRC		3 A	11	no	500	H05 VV-F	6.396,-	
	1,5	8 + 2	6070/PRC		4,5 A	13	no	500	H05 VV-F	6.396,-	
	2,5	6 + 2	6061/PRC		7,5 A	15	no	500	H05 VV-F	6.495,-	
10 x	1	8 + 2	6095/PRC		3 A	13	no	500	H05 VV-F	8.840,-	
	1,5	6 + 2	6619/PRC		4,5 A	15	no	500	H05 VV-F	8.840,-	
12 x	1	10 + 2	6591/PRC **		3 A	13,5	no	500	H05 VV-F	10.347,-	
	1,5	6 + 2	6593/PRC **		4,5 A	15,5	no	500	H05 VV-F	10.347,-	
16 x	1	6 + 2	6096/PRC **		3 A	15	no	500	H05 VV-F	11.287,-	

DIMENSION

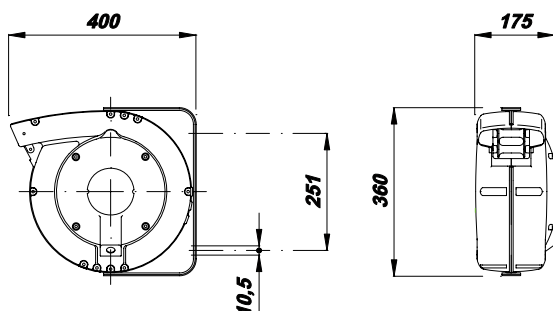

Finder du ikke hvad du søger, så ring endelig og hør nærmere om andre modeller.





BESKRIVELSE

- Kraftig kabelopruller i støbt aluminiumsboks
- Styreruller
- Palstop for hver 50 cm. Kan deaktiveres
- IP 65 beskyttelses klasse
- Arbejdstemperatur -5°C - +50°C
- Kan leveres med PVC eller gummi kabel i
- Leveres med 2 meter tilslutningskabel
- Diverse størrelser og længder. Se næste side

EN 61242 EN 60335-1

CE

2006/95/CE 2006/42/CE
2011/65/UE

Antal ledere	mm ²	Længde i meter	Bestillings nr.	Bestillings nr.	KW  @20°C	KW  @20°C	Kabel diameter Ø	Termo sirking	Frostøkket samler	V max	Kabel type	Serie PRC Pris	Serie PRL Pris							
														230V	230V	400V	400V			
1 x	6	22 + 2	6195/PRC/IP65	6386/PRL/IP65			5,5	no	*		H05 VV-F	7.315,-	7.875,-							
	16	15 + 2	6193/PRC/IP65	6384/PRL/IP65			8	no	*		H05 VV-F	8.050,-	8.575,-							
2 x	1	24 + 2	6192/PRC/IP65	6383/PRL/IP65	1,0	1,1	1,7	6	no	500	H05 VV-F	6.615,-	7.140,-							
	1,5	24 + 2	6191/PRC/IP65	6382/PRL/IP65			1,8	8	no			H05 VV-F	7.000,-	7.490,-						
	2,5	21 + 2	6189/PRC/IP65	6380/PRL/IP65			1,8	2,5	9		no	*	H05 VV-F	7.140,-	7.700,-					
			6190/PRC/IP65	6381/PRL/IP65											7.490,-	8.050,-				
3 G	1	24 + 2	6187/PRC/IP65	6378/PRL/IP65	1,0	1,1	1,7	6,5	no	500	H05 VV-F	7.525,-	8.050,-							
	1,5	24 + 2	6186/PRC/IP65	6377/PRL/IP65			1,1	1,8	7		no		H05 VV-F	7.700,-	8.225,-					
			6186/PRC/IP65 RNF	6377/PRL/IP65 RNF									9,5	no	750	H07 RN-F	7.875,-	8.400,-		
	2,5	15 + 2	6184/PRC/IP65	6375/PRL/IP65			2,0	3,0	10		no	*	500	H05 VV-F	7.525,-	8.050,-				
			6185/PRC/IP65	6376/PRL/IP65												7.875,-	8.400,-			
			6184/PRC/IP65 RNF	6375/PRL/IP65 RNF										11,5	no	*	750	H07 RN-F	7.315,-	7.875,-
			6185/PRC/IP65 RNF	6376/PRL/IP65 RNF															7.700,-	8.225,-
	4 G	1	24 + 2	6182/PRC/IP65			6373/PRL/IP65	0,8	1,1		1,4	7	no	500	H05 VV-F	7.875,-	8.400,-			
		1,5	21 + 2	6181/PRC/IP65			6372/PRL/IP65				1,1	1,8	8,5		no		H05 VV-F	8.225,-	8.750,-	
				6181/PRC/IP65 RNF			6372/PRL/IP65 RNF										10,5	no	750	H07 RN-F
2,5		15 + 2	6179/PRC/IP65	6370/PRL/IP65	2,0	3,0	11			no	*	500	H05 VV-F		7.700,-	8.225,-				
			6521/PRC/IP65	6525/PRL/IP65												8.225,-	8.750,-			
			6179/PRC/IP65 RNF	6370/PRL/IP65 RNF									12,5		no	*	750	H07 RN-F	7.700,-	8.225,-
			6521/PRC/IP65 RNF	6525/PRL/IP65 RNF															8.225,-	8.750,-
5 G		1	16 + 2	6063/PRC/IP65	6136/PRL/IP65	0,8	1,5			1,4	7,5	no	500		H05 VV-F	7.525,-	8.050,-			
	1,5	15 + 2	6067/PRC/IP65	6140/PRL/IP65	2,0			3,0	12,5	no		H05 VV-F		8.050,-	8.575,-					
	2,5	10 + 2	6022/PRC/IP65	6154/PRL/IP65								13,5		no	750	H07 RN-F	7.875,-	8.400,-		
			6022/PRC/IP65 RNF	6154/PRL/IP65 RNF					7.490,-	8.050,-										
7 x	1	16 + 2	6065/PRC/IP65	6138/PRL/IP65	3A		8,5	no		500	H05 VV-F	8.750,-	9.275,-							
	1,5	9 + 2	6069/PRC/IP65	6142/PRL/IP65	4,5A		10,5	no		500	H05 VV-F	8.925,-	9.450,-							
8 x	1	11 + 2	6066/PRC/IP65	6139/PRL/IP65	3A		10	no		500	H05 VV-F	8.925,-	9.450,-							
	1,5	8 + 2	6070/PRC/IP65	6143/PRL/IP65	4,5A		11,5	no		500	H05 VV-F	8.925,-	9.450,-							

Tilbehør

ART. 953 - Rulle kabelguide for kabeltromler i PR serien. Essentiel for loftmontering.

ART. 6100 - PRC til PRL konverteringsæt.

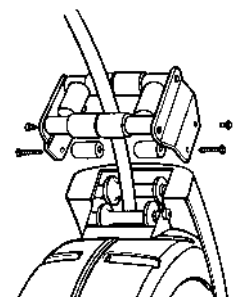

Dimensioner

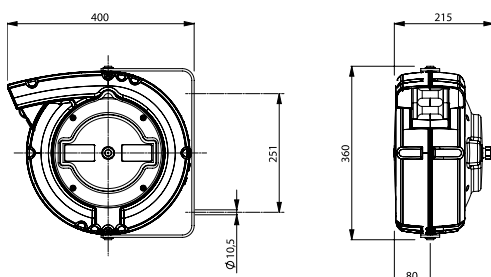



BESKRIVELSE

- Industrikabelopruller i aluminium/stål
- IP 65 beskyttelsesklasse
- Arbejdstemperatur -5°C - +50°C
- Kan leveres med PVC, gummi- eller uden kabel i diverse størrelser og længder op til 24 meter. Se næste side
- Se muligheder for beslag og guidearme i skemaet side 129

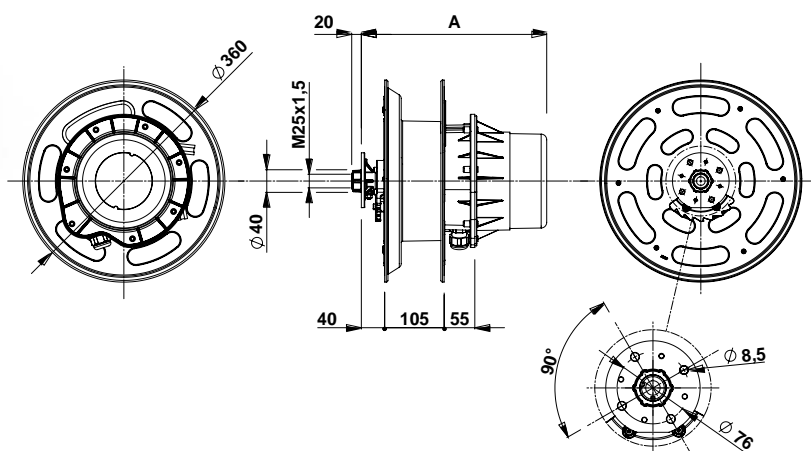

Disse oprullere leveres normalt uden beslag, uden kabelguide og uden låsemekanisme. Disse artikler kan købes separat, se næste side.



Disse ruller er med eller uden kabel. Se tabellen næste side.



EN 61242
EN 61316

CE

2006/95/CE 2006/42/CE
2011/65/UE

Antal ledere	mm ²	Slæbering Kapacitet (A)	Længde i meter	Bestillings nr.	KW		Kabel type	Kabel diameter	Dimension	Pris	
											
1 x	16	50	20+2	1420	50A		H05 V-F	8	330	8.925,-	
	25	100	18+2	1421	100A			10		9.975,-	
3 G	2,5	20	20+2	1428	230V	2,0	230V	3,5	330	8.925,-	
			18+2	1428 RNF				11,5		8.925,-	
			23+2	1429				Igus CF900		8,5	9.625,-
	4	50	15+2	1430	3,0	5,0	H05 VV-F	12,5	330	9.625,-	
4 G	1,5	20	20+2	1432 RNF	400V 3F+T	4,0	400V 3F+T	6,0	330	9.275,-	
			18+2	1434				H07 RN-F		10,5	9.450,-
			15+2	1434 RNF				H05 VV-F		11	9.450,-
			18+2	1435				H07 RN-F		12,5	10.150,-
	2,5	50	18+2	1435 RNF	7,0	10,0	H05 VV-F	11	10.150,-		
			15+2	1436 RNF			H07 RN-F	12,5	10.150,-		
	4	50	12+2	1436	11,0	15,0	H05 VV-F	14	10.500,-		
			10+2	1436 RNF			H07 RN-F	15	10.500,-		
6	50	8+2	1438 RNF	17,0	22,0	H07 RN-F	17	330	8.925,-		
5 G	1,5	20	18+2	1440	400V 3F+T+N	4,0	400V 3F+T+N	6,0	330	9.625,-	
			15+2	1440 RNF				H07 RN-F		12	9.625,-
	2,5	20	15+2	1442	7,0	10,0	H05 VV-F	12,5	10.150,-		
			12+2	1442 RNF			H07 RN-F	13,5	10.150,-		
		15+2	1443	H05 VV-F			12,5	10.710,-			
		12+2	1443 RNF	H07 RN-F			13,5	10.710,-			
	4	50	8+2	1444 RNF	11,0	15,0	H07 RN-F	16,5	330	11.025,-	
	8 x	1	20	18+2	1450	3A		H05 VV-F	10	330	11.025,-
1,5		15+2		1452	4,5A		11,5		11.375,-		
2,5		12+2		1454	7,5A		14		11.810,-		
12 x	1	20	15+2	1460	3A		H05 VV-F	13	380	13.390,-	
	1,5		12+2	1462	4,5A			13,5		13.740,-	
	2,5		8+2	1464	7,5A			16,5		13.920,-	

Svirvel beslag

Bestilling nr.: 1401

- Kun velegnet hvis kabeloprulleren anvendes manuelt.
- Kan installeres med styrerulle nr: 1406.

PRIS: 560,00



Fast beslag

Bestilling nr.: 1403

- Til væg-, gulv- eller loftmontering.
- Kan installeres med styrerulle nr: 1406

PRIS: 240,00



Arm med styrerulle

Bestilling nr.: 1406

- Komplet med låsemekanisme.

PRIS: 700,00





Manufactured according to standard:
 Construit selon norme:
 EN 61242 EN 60335-1

CE 

These products comply with Directives:
 Produits conformes aux Directives:
 2006/95/CE 2006/42/CE 2002/95/CE

BESKRIVELSE

- Industrikabelopruller i aluminium/stål
- IP 65 beskyttelsesklasse
- Arbejdstemperatur -5°C - +40°C
- Kan leveres med PVC, gummi- eller uden kabel i diverse størrelser og længder op til 53 meter. Se næste sider
- Leveres med 2,5 meter tilslutningskabel
- Se muligheder for beslag og guidearme i skemaet side 15-17

KABELOPRULLER TYPE 1

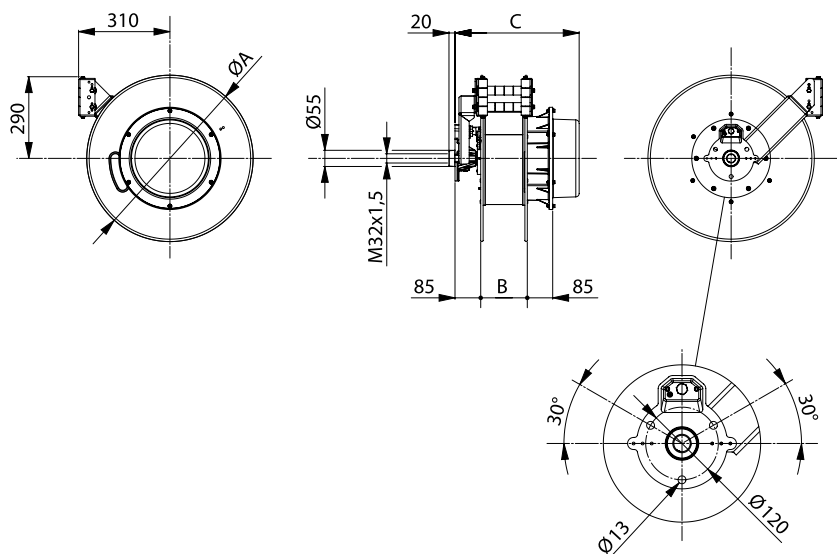

KABELOPRULLER TYPE 2

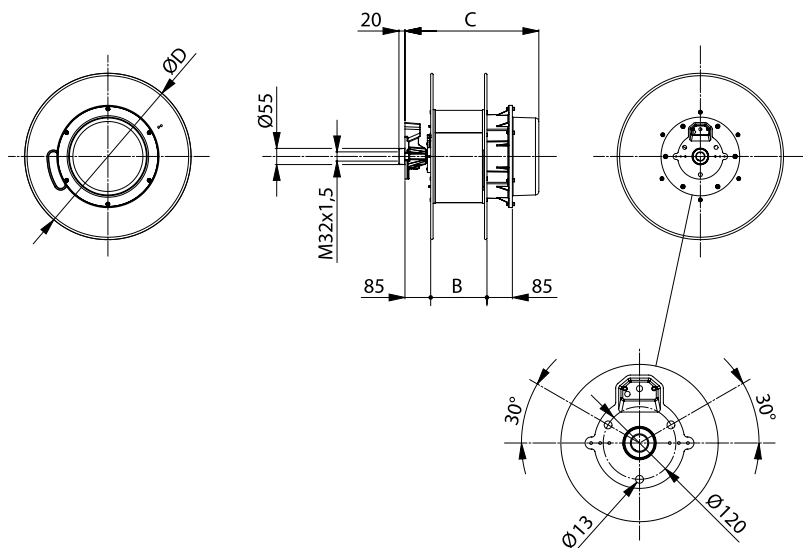



VÆGBESLAG 1703

- 1703 Vægbeslag for serie 1700
NB. Guidearm bestilles separat

PRIS: 1.538,00



DREJELIGT VÆGBESLAG 1701

- 1701 Drejeligt vægbeslag for serie 1700
NB. Guidearm bestilles separat

PRIS: 2.275,00



GUIDEARM 1706 & 1707



- 1706 Guidearm for serie 1700 – 115mm
PRIS: 1.400,00
- 1707 Guidearm for serie 1700 – 145mm
PRIS: 1.842,00



SVIRVELARM 1704 & 1708



- 1704 Svirvelarm for serie 1700 – 160mm
PRIS: 1.435,00
- 1708 Svirvelarm for serie 1700 – 190mm
PRIS: 1.435,00

NB. Kan ikke monteres sammen med vægbeslag og skal betilles og monteres fra fabrikken.

Antal ledere	mm ²	Længde i meter	Best. Nr.	Slebering kapacitet (A)	KW		Kabel mm.	Kabel Type	Valgfri beslag Guidearm						Dimension				Pris											
					 (20°C)	 (20°C)			1701	1703	1704	1706	1707	1708	Type	A	B	C		D										
1 x	16	30 + 2	1711	60			8	H05 V-F							1					14.870,-										
	25	30 + 2	1712	100			10								1					16.841,-										
3 G	2,5	39 + 2	1718	16	230V	2,0	230V	3,5	9,5	H05 VV-F							1	Ø 440	160	365	17.378,-									
			12						H07 RN-F						1								1				17.737,-			
4 G	2,5	39 + 2	1723	32	400V	6,0	400V	8,5	11	H05 VV-F							1	Ø 550			19.169,-									
			13						H07 RN-F						1								1				19.169,-			
		11	H05 VV-F											2	190	395	Ø 440				Ø 550	21.500,-								
		13	H07 RN-F										2												2				21.500,-	
	4	29 + 2	1730	32				11,0	15,0	14	H05 VV-F							1	Ø 550	160	365	410	18.990,-							
			1731	60													1									1				19.704,-
		43 + 2	1732	32								10,0	13,5	15	H07 RN-F											2				21.500,-
		38 + 2	1732 RNF	60																					2	395				Ø 550
	43 + 2	1733	60							2									23.290,-											
	38 + 2	1733 RNF	60							2									23.290,-											
	6	38 + 2	1739	60		17,0	22,0	17	H05 VV-F							2				24.547,-										
			1739 RNF	100											2	190				440	Ø 650	25.083,-								
			1740	100											2											26.874,-				
			1740 RNF	100											2											27.770,-				
	10	23 + 2	1744	60		25,0	30,0	22	H05 VV-F								2						26.874,-							
			1745	100											2	Ø 550					28.665,-									
38 + 2		1746	60										2											29.023,-						
1747		100										2											32.249,-							
16	28 + 2	1750	100	35,0	40,0	24							2						34.040,-											
5 G	2,5	29 + 2	1754	32	7,0	9,5	H05 VV-F							1	Ø 550	160	365	18.990,-												
			1754 RNF					1					1							19.707,-										
		53 + 2	1755					60	6,0	8,5	12,5	H05 VV-F									2	190	395	Ø 440	23.290,-					
		1755 RNF	2																2							29.740,-				
	38 + 2	1761	60												2	440	Ø 550		25.977,-											
	28 + 2	1761 RNF	100												1				Ø 550	160	410				25.977,-					
	38 + 2	1762	100								2	190	440	Ø 550	28.665,-															
	1762 RNF	100								1	Ø 550	160	410	28.665,-																
8 x	1,5	38 + 2	1765	16	4,5A	13	H05 VV-F							1	Ø 550	160	410	23.290,-												
	2,5	38 + 2	1768	16	7,5A	15								2			440	24.187,-												
		53 + 2	1769	16									2							26.526,-										
10 x	1,5	53 + 2	1773	16			4,5A	15	H05 VV-F									2	190	Ø 550		28.665,-								
12 x	1,5	53 + 2	1777	16	4,5A	15,5	H05 VV-F						2		510		31.353,-													
16 x	1	30 + 2	1778	16	3A	15	H05 VV-F							2				27.770,-												
	1,5	24 + 2	1780	16	4,5A	18								1	Ø 550	160	480	28.665,-												
		38 + 2	1781	16									2	190	510	Ø 550	31.890,-													
	2,5	24 + 2	1783	16				7,5A	20							1	Ø 550	160	480	29.740,-										
38 + 2		1784	16										2	190	510	Ø 650	33.144,-													
24 x	1,5	23 + 2	1788	16	4,5A	21,5	H05 VV-F									2	190	610	Ø 550	35.832,-										
		38 + 2	1789							16					2	190	610	Ø 650	40.310,-											

N.B.: Alle modeller kan også leveres uden kabel.
Tilføj SC til Best. Nr.

Finder du ikke hvad du søger, så ring endelig og hør nærmere om andre modeller.

Antal ledere	mm ²	Længde i meter	Best. Nr	Slæbning kapacitet (A)	KW		Kabel mm.	Kabel Type	Valgfri beslag						Dimension				Pris															
					 (20°C)	 (20°C)			Guidearm						Type	A	B	C		D														
3 G	2,5	29 + 2	1717	16	230V	2,0	230V	3,5	9,5	H05 VV-F	1701	1703	1704	1706	1707	1708	Type	Ø 440	365	160	410	365	16.662,-											
			1717 RNF						12	H07 RN-F							1										1						16.662,-	
4 G	2,5	20 + 2	1721	32	400V	7,0	400V	9,5	11	H05 VV-F								Ø 440	365	160	410	365	15.766,-											
			1721 RNF						13	H07 RN-F																							13.437,-	
		1722	11						H05 VV-F																								18.274,-	
		1722 RNF	13						H07 RN-F																								18.274,-	
	4	20 + 2	15 + 2	1726	32	400V	11,0	400V	15,0	14	H05 VV-F								Ø 440	365	160	410	365	16.841,-										
				1726 RNF						15	H07 RN-F																							16.841,-
			1727	14						H05 VV-F																								17.917,-
			1727 RNF	15						H07 RN-F																								17.917,-
		24 + 2	15 + 2	1728	32	400V	11,0	400V	15,0	14	H05 VV-F									Ø 550	365	160	410	365	18.811,-									
				1728 RNF						15	H07 RN-F																							19.708,-
			1729	14						H05 VV-F																								19.708,-
			1729 RNF	15						H07 RN-F																								20.802,-
	6	15 + 2	15 + 2	1735	60	400V	17,0	400V	22,0	17	H05 VV-F								Ø 550	160	410	410	Ø 550	18.453,-										
				1735 RNF						18	H07 RN-F																							19.170,-
			1736	17						H05 VV-F																								21.499,-
			1736 RNF	18						H07 RN-F																								22.395,-
		24 + 2	15 + 2	1737	60	400V	17,0	400V	22,0	17	H05 VV-F									Ø 550	160	410	410	Ø 550	22.395,-									
				1737 RNF						18	H07 RN-F																							23.290,-
			1738	17						H05 VV-F																								25.082,-
			1738 RNF	18						H07 RN-F																								25.620,-
10	14 + 2	1742	60	400V	25,0	400V	30,0	22	H05 VV-F									Ø 550	160	410	Ø 550	21.499,-												
		1743						100																							23.290,-			
16	14 + 2	1749	100	400V	35,0	400V	40,0	24	H05 VV-F														26.874,-											
5 G	2,5	20 + 2	1752	32	400V	7,0	400V	9,5	12,5	H05 VV-F								Ø 440	365	160	410	365	16.304,-											
			1752 RNF						14	H07 RN-F																								16.304,-
		1753	12,5						H05 VV-F																									18.454,-
		1753 RNF	14						H07 RN-F																									19.708,-
	6	15 + 2	1757	60	400V	17,0	400V	22,0	17,5	H05 VV-F									Ø 550	160	410	410	Ø 550	20.067,-										
			1757 RNF						18,5	H07 RN-F																								21.499,-
		1758	17,5						H05 VV-F																									23.290,-
		1758 RNF	18,5						H07 RN-F																									24.723,-
24 + 2	15 + 2	1759	60	400V	17,0	400V	17,5	H05 VV-F										Ø 550	160	410	410	Ø 550	24.187,-											
		1760						100																								25.977,-		
8x	1,5	20 + 2	1764	16	4,5A	13	H05 VV-F											Ø 440	160	410	410	Ø 440	18.274,-											
		15 + 2	1766	16	7,5A	15																						17.916,-						
	24 + 2	1767	16	7,5A	15																								22.216,-					
10x	1,5	15 + 2	1771	16	4,5A	15	H05 VV-F											Ø 440	160	410	410	Ø 440	19.708,-											
		24 + 2	1772					16	4,5A	15																					23.290,-			
12x	1,5	15 + 2	1775	16	4,5A	15,5	H05 VV-F											Ø 440	160	410	410	Ø 440	20.783,-											
		24 + 2	1776					16	4,5A	15,5																					25.083,-			
16x	1,5	16 + 2	1779	16	4,5A	18	H05 VV-F											Ø 550	160	410	410	Ø 550	24.187,-											
	2,5	16 + 2	1782		16	7,5A		20																					26.874,-					
24x	1,5	14 + 2	1787	16	4,5A	21,5	H05 VV-F																32.249,-											

Finder du ikke hvad du søger, så ring endelig og hør nærmere om andre modeller.

Rectus Serie	13	14	18	19	20	21C	22	23 24	25 26	27	30	31	32	33	34	37 83	38	39	40	41	60	71 76	95	96
Fabrikat																								
Atlas Copco - QIC 08								X																
Atlas Copco - QIC 10															X									
Atlas Copco - QIC 15																X								
Cejn 220						X																		
Cejn 291			X																					
Cejn 300		X																						
Cejn 310								X																
Cejn 320									X															
Cejn 341-342-343-345-346																								X
Cejn 344																							X	
Cejn 410										X														
Cejn 417																				X				
Cejn 550																X								
Festo					X																			
Hansen 1000								X																
Hansen 3000								X																
Hansen 4000											X													
Hansen 5000																X								
Hansen 6000																	X							
Hansen 7000																		X						
Hansen 1Hk - 8 HK																						X		
JWL 520+530									X															
JWL 521+531								X																
JWL 522+532							X																	
KS 1/4" Serien																					X			
Nitto Kohki	X																							
Orion 44510		X					X																	
Orion 44520																			X					
PCL Standard				X																				
Tema 1300												X												
Tema 1400								X																
Tema 1600									X															
Tema 1700										X														
Tema 1800													X											

Priserne i dette katalog er eksklusive moms, andre afgifter, fragt og emballage og kan ændres uden varsel.
Der tages forbehold for tryk- og prisfejl.

HOS FLOWCONCEPT ER DER INGEN EKSPEDITIONSGBYR

claber®

QUICK-CLICK LYNKOBLING

Yderst praktisk og max holdbarhed: Claber design på højeste niveau i den nye Quick-Click serie, med eller uden vandstop. Rustfri (ingen metal dele) og stødsikkert design. Resistente overfor UV stråler og kan samtidig holde til et stort tryk (op til 40 bars sprængningstryk, som er langt over det normale brugs vandtryk). Den interne fjeder – endnu et eksklusivt Claber patent – gør at lynkoblingen kan holde til 1,5 million "tilkoblinger" uden problemer. På grund af den internationale koblingsprofil kan Quick-Click serien anvendes sammen med andre gængse mærker på markedet.

Plastik materiale som er resistent overfor påvirkninger fra barskt vejr og UV stråler.

Fejlfri vandtæt pakning selv efter 1 million tilkoblinger.

Ergonomisk design til mindste detalje.

SE CLABER I SEPERAT KATALOG



FLOWCONCEPT APS | LANGBALLE 8 | DK - 8700 HORSENS
TEL +45 7561 5555 | **FAX** +45 7561 8855 | **MAIL** INFO@FLOWCONCEPT.DK | **WEB** WWW.FLOWCONCEPT.DK